

Q. 1 – Q. 5 carry one mark each.

Q.1 The volume of a sphere of diameter 1 unit is _____ than the volume of a cube of side 1 unit.
(A) least (B) less (C) lesser (D) low

Q.2 The unruly crowd demanded that the accused be _____ without trial.
(A) hanged (B) hanging (C) hankering (D) hung

Q.3 Choose the statement(s) where the underlined word is used correctly:

- (i) A prone is a dried plum.
- (ii) He was lying prone on the floor.
- (iii) People who eat a lot of fat are prone to heart disease.

(A) (i) and (iii) only (B) (iii) only (C) (i) and (ii) only (D) (ii) and (iii) only

Q.4 **Fact:** If it rains, then the field is wet.

Read the following statements:

- (i) It rains
- (ii) The field is not wet
- (iii) The field is wet
- (iv) It did not rain

Which one of the options given below is **NOT** logically possible, based on the given fact?

- (A) If (iii), then (iv).
- (B) If (i), then (iii).
- (C) If (i), then (ii).
- (D) If (ii), then (iv).

Q.5 A window is made up of a square portion and an equilateral triangle portion above it. The base of the triangular portion coincides with the upper side of the square. If the perimeter of the window is 6 m, the area of the window in m^2 is _____.

- (A) 1.43 (B) 2.06 (C) 2.68 (D) 2.88

Q. 6 – Q. 10 carry two marks each.

Q.6 Students taking an exam are divided into two groups, **P** and **Q** such that each group has the same number of students. The performance of each of the students in a test was evaluated out of 200 marks. It was observed that the mean of group **P** was 105, while that of group **Q** was 85. The standard deviation of group **P** was 25, while that of group **Q** was 5. Assuming that the marks were distributed on a normal distribution, which of the following statements will have the highest probability of being **TRUE**?

- (A) No student in group **Q** scored less marks than any student in group **P**.
- (B) No student in group **P** scored less marks than any student in group **Q**.
- (C) Most students of group **Q** scored marks in a narrower range than students in group **P**.
- (D) The median of the marks of group **P** is 100.

Q.7 A smart city integrates all modes of transport, uses clean energy and promotes sustainable use of resources. It also uses technology to ensure safety and security of the city, something which critics argue, will lead to a surveillance state.

Which of the following can be logically inferred from the above paragraph?

- (i) All smart cities encourage the formation of surveillance states.
- (ii) Surveillance is an integral part of a smart city.
- (iii) Sustainability and surveillance go hand in hand in a smart city.
- (iv) There is a perception that smart cities promote surveillance.

- (A) (i) and (iv) only
- (B) (ii) and (iii) only
- (C) (iv) only
- (D) (i) only

Q.8 Find the missing sequence in the letter series.

B, FH, LNP, _ _ _ _ .

- (A) SUWY
- (B) TUVW
- (C) TVXZ
- (D) TWXZ

Q.9 The binary operation \square is defined as $a \square b = ab + (a+b)$, where a and b are any two real numbers. The value of the identity element of this operation, defined as the number x such that $a \square x = a$, for any a , is _____.

- (A) 0
- (B) 1
- (C) 2
- (D) 10

- Q.10 Which of the following curves represents the function $y = \ln(|e^{|\sin(|x|)|}|)$ for $|x| < 2\pi$? Here, x represents the abscissa and y represents the ordinate.

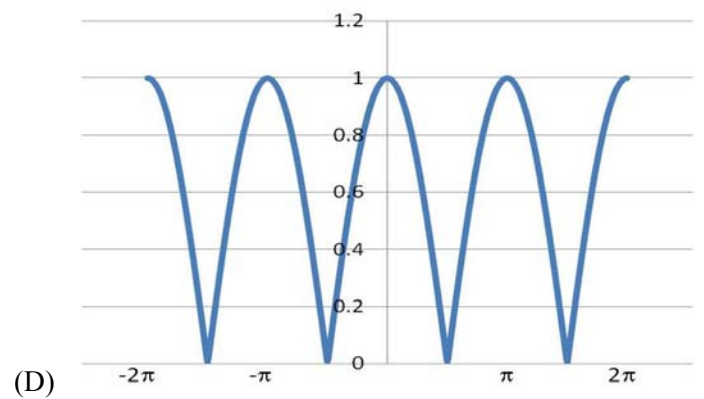
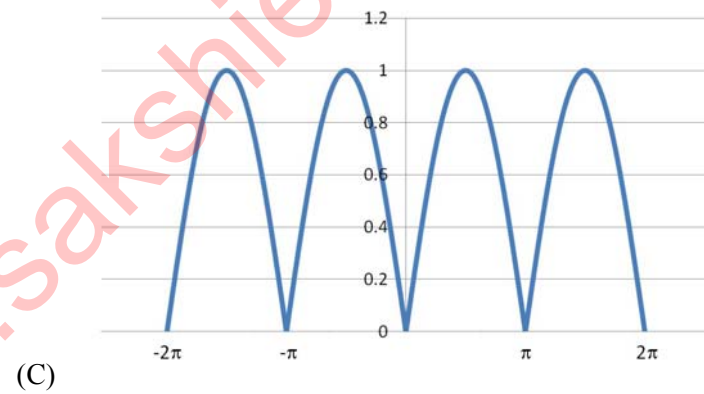
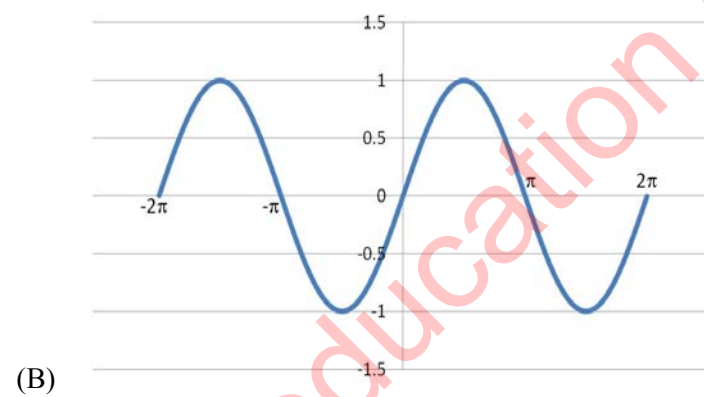
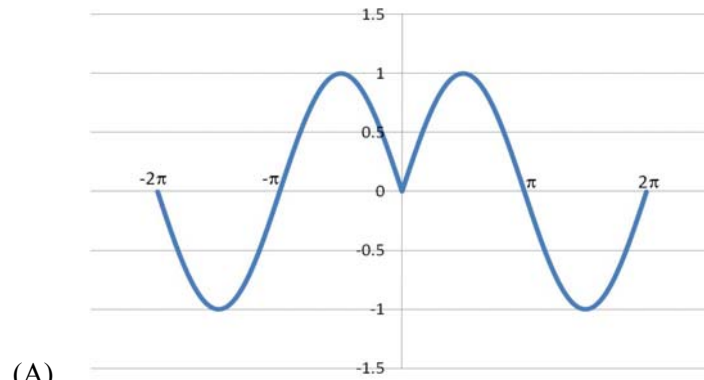

END OF THE QUESTION PAPER

Q. 1 – Q. 25 carry one mark each.

- Q.1 Consider the linear differential equation $\frac{dy}{dx} = xy$. If $y = 2$ at $x = 0$, then the value of y at $x=2$ is given by
- (A) e^{-2} (B) $2e^{-2}$
(C) e^2 (D) $2e^2$
- Q.2 Which of the following magnetic vector potentials gives rise to a uniform magnetic field $B_0 \hat{k}$?
- (A) $B_0 z \hat{k}$ (B) $-B_0 x \hat{j}$
(C) $\frac{B_0}{2}(-y \hat{i} + x \hat{j})$ (D) $\frac{B_0}{2}(y \hat{i} + x \hat{j})$
- Q.3 The molecule $^{17}\text{O}_2$ is
- (A) Raman active but not NMR (nuclear magnetic resonance) active.
(B) Infrared active and Raman active but not NMR active.
(C) Raman active and NMR active.
(D) Only NMR active.
- Q.4 There are four electrons in the $3d$ shell of an isolated atom. The total magnetic moment of the atom in units of Bohr magneton is _____.
- Q.5 Which of the following transitions is NOT allowed in the case of an atom, according to the electric dipole radiation selection rule?
- (A) $2s-1s$ (B) $2p-1s$ (C) $2p-2s$ (D) $3d-2p$
- Q.6 In the SU(3) quark model, the triplet of mesons (π^+, π^0, π^-) has
- (A) Isospin = 0, Strangeness = 0
(B) Isospin = 1, Strangeness = 0
(C) Isospin = 1/2, Strangeness = +1
(D) Isospin = 1/2, Strangeness = -1
- Q.7 The magnitude of the magnetic dipole moment associated with a square shaped loop carrying a steady current I is m . If this loop is changed to a circular shape with the same current I passing through it, the magnetic dipole moment becomes $\frac{pm}{\pi}$. The value of p is _____.
- Q.8 The total power emitted by a spherical black body of radius R at a temperature T is P_1 . Let P_2 be the total power emitted by another spherical black body of radius $R/2$ kept at temperature $2T$. The ratio, P_1/P_2 is _____. (Give your answer upto two decimal places)

- Q.9 The entropy S of a system of N spins, which may align either in the upward or in the downward direction, is given by $S = -k_B N [p \ln p + (1-p) \ln(1-p)]$. Here k_B is the Boltzmann constant. The probability of alignment in the upward direction is p . The value of p , at which the entropy is maximum, is _____. (Give your answer upto one decimal place)
- Q.10 For a system at constant temperature and volume, which of the following statements is correct at equilibrium?
- (A) The Helmholtz free energy attains a local minimum.
(B) The Helmholtz free energy attains a local maximum.
(C) The Gibbs free energy attains a local minimum.
(D) The Gibbs free energy attains a local maximum.
- Q.11 N atoms of an ideal gas are enclosed in a container of volume V . The volume of the container is changed to $4V$, while keeping the total energy constant. The change in the entropy of the gas, in units of $Nk_B \ln 2$, is _____, where k_B is the Boltzmann constant.
- Q.12 Which of the following is an analytic function of z everywhere in the complex plane?
- (A) z^2 (B) $(z^*)^2$ (C) $|z|^2$ (D) \sqrt{z}
- Q.13 In a Young's double slit experiment using light, the apparatus has two slits of unequal widths. When only slit-1 is open, the maximum observed intensity on the screen is $4I_0$. When only slit-2 is open, the maximum observed intensity is I_0 . When both the slits are open, an interference pattern appears on the screen. The ratio of the intensity of the principal maximum to that of the nearest minimum is _____.
- Q.14 Consider a metal which obeys the Sommerfeld model exactly. If E_F is the Fermi energy of the metal at $T = 0$ K and R_H is its Hall coefficient, which of the following statements is correct?
- (A) $R_H \propto E_F^{3/2}$ (B) $R_H \propto E_F^{2/3}$ (C) $R_H \propto E_F^{-3/2}$ (D) R_H is independent of E_F
- Q.15 A one-dimensional linear chain of atoms contains two types of atoms of masses m_1 and m_2 (where $m_2 > m_1$), arranged alternately. The distance between successive atoms is the same. Assume that the harmonic approximation is valid. At the first Brillouin zone boundary, which of the following statements is correct?
- (A) The atoms of mass m_2 are at rest in the optical mode, while they vibrate in the acoustical mode.
(B) The atoms of mass m_1 are at rest in the optical mode, while they vibrate in the acoustical mode.
(C) Both types of atoms vibrate with equal amplitudes in the optical as well as in the acoustical modes.
(D) Both types of atoms vibrate, but with unequal, non-zero amplitudes in the optical as well as in the acoustical modes.
- Q.16 Which of the following operators is Hermitian?
- (A) $\frac{d}{dx}$ (B) $\frac{d^2}{dx^2}$ (C) $i \frac{d^2}{dx^2}$ (D) $\frac{d^3}{dx^3}$

- Q.17 The kinetic energy of a particle of rest mass m_0 is equal to its rest mass energy. Its momentum in units of m_0c , where c is the speed of light in vacuum, is _____. (Give your answer upto two decimal places)
- Q.18 The number density of electrons in the conduction band of a semiconductor at a given temperature is $2 \times 10^{19} \text{ m}^{-3}$. Upon lightly doping this semiconductor with donor impurities, the number density of conduction electrons at the same temperature becomes $4 \times 10^{20} \text{ m}^{-3}$. The ratio of majority to minority charge carrier concentration is _____.
- Q.19 Two blocks are connected by a spring of spring constant k . One block has mass m and the other block has mass $2m$. If the ratio $k/m = 4 \text{ s}^{-2}$, the angular frequency of vibration ω of the two block spring system in s^{-1} is _____. (Give your answer upto two decimal places)
- Q.20 A particle moving under the influence of a central force $\vec{F}(\vec{r}) = -k\vec{r}$ (where \vec{r} is the position vector of the particle and k is a positive constant) has non-zero angular momentum. Which of the following curves is a possible orbit for this particle?
- (A) A straight line segment passing through the origin.
(B) An ellipse with its center at the origin.
(C) An ellipse with one of the foci at the origin.
(D) A parabola with its vertex at the origin.
- Q.21 Consider the reaction ${}_{25}^{54}\text{Mn} + e^- \rightarrow {}_{24}^{54}\text{Cr} + X$. The particle X is
- (A) γ (B) ν_e (C) n (D) π^0
- Q.22 The scattering of particles by a potential can be analyzed by Born approximation. In particular, if the scattered wave is replaced by an appropriate plane wave, the corresponding Born approximation is known as the first Born approximation. Such an approximation is valid for
- (A) large incident energies and weak scattering potentials.
(B) large incident energies and strong scattering potentials.
(C) small incident energies and weak scattering potentials.
(D) small incident energies and strong scattering potentials.
- Q.23 Consider an elastic scattering of particles in $l = 0$ states. If the corresponding phase shift δ_0 is 90° and the magnitude of the incident wave vector is equal to $\sqrt{2\pi} \text{ fm}^{-1}$ then the total scattering cross section in units of fm^2 is _____.
- Q.24 A hydrogen atom is in its ground state. In the presence of a uniform electric field $\vec{E} = E_0\hat{z}$, the leading order change in its energy is proportional to $(E_0)^n$. The value of the exponent n is _____.

- Q.25 A solid material is found to have a temperature independent magnetic susceptibility, $\chi = C$. Which of the following statements is correct?
- (A) If C is positive, the material is a diamagnet.
 (B) If C is positive, the material is a ferromagnet.
 (C) If C is negative, the material could be a type I superconductor.
 (D) If C is positive, the material could be a type I superconductor.

Q. 26 – Q. 55 carry two marks each.

- Q.26 An infinite, conducting slab kept in a horizontal plane carries a uniform charge density σ . Another infinite slab of thickness t , made of a linear dielectric material of dielectric constant k , is kept above the conducting slab. The bound charge density on the upper surface of the dielectric slab is

- (A) $\frac{\sigma}{2k}$ (B) $\frac{\sigma}{k}$
 (C) $\frac{\sigma(k-2)}{2k}$ (D) $\frac{\sigma(k-1)}{k}$

- Q.27 The number of spectroscopic terms resulting from the $\mathbf{L} \cdot \mathbf{S}$ coupling of a $3p$ electron and a $3d$ electron is _____.

- Q.28 Which of the following statements is NOT correct?

- (A) A deuteron can be disintegrated by irradiating it with gamma rays of energy 4 MeV.
 (B) A deuteron has no excited states.
 (C) A deuteron has no electric quadrupole moment.
 (D) The 1S_0 state of deuteron cannot be formed.

- Q.29 If \vec{s}_1 and \vec{s}_2 are the spin operators of the two electrons of a He atom, the value of $\langle \vec{s}_1 \cdot \vec{s}_2 \rangle$ for the ground state is

- (A) $-\frac{3}{2}\hbar^2$ (B) $-\frac{3}{4}\hbar^2$ (C) 0 (D) $\frac{1}{4}\hbar^2$

- Q.30 A two-dimensional square rigid box of side L contains six non-interacting electrons at $T = 0$ K. The mass of the electron is m . The ground state energy of the system of electrons, in units of $\frac{\pi^2 \hbar^2}{2mL^2}$ is _____.

- Q.31 An alpha particle is accelerated in a cyclotron. It leaves the cyclotron with a kinetic energy of 16 MeV. The potential difference between the D electrodes is 50 kilovolts. The number of revolutions the alpha particle makes in its spiral path before it leaves the cyclotron is _____.

- Q.32 Let V_i be the i^{th} component of a vector field \vec{V} , which has zero divergence. If $\partial_j \equiv \partial/\partial x_j$, the expression for $\epsilon_{ijk} \epsilon_{lmk} \partial_j \partial_l V_m$ is equal to

- (A) $-\partial_j \partial_k V_i$ (B) $\partial_j \partial_k V_i$ (C) $\partial_j^2 V_i$ (D) $-\partial_j^2 V_i$

Q.33 The direction of $\vec{\nabla}f$ for a scalar field $f(x, y, z) = \frac{1}{2}x^2 - xy + \frac{1}{2}z^2$ at the point $P(1, 1, 2)$ is

- (A) $\frac{(-\hat{j} - 2\hat{k})}{\sqrt{5}}$ (B) $\frac{(-\hat{j} + 2\hat{k})}{\sqrt{5}}$ (C) $\frac{(\hat{j} - 2\hat{k})}{\sqrt{5}}$ (D) $\frac{(\hat{j} + 2\hat{k})}{\sqrt{5}}$

Q.34 σ_x, σ_y and σ_z are the Pauli matrices. The expression $2\sigma_x\sigma_y + \sigma_y\sigma_x$ is equal to

- (A) $-3i\sigma_z$ (B) $-i\sigma_z$ (C) $i\sigma_z$ (D) $3i\sigma_z$

Q.35 A particle of mass $m = 0.1$ kg is initially at rest at origin. It starts moving with a uniform acceleration $\vec{a} = 10\hat{i}$ ms⁻² at $t = 0$. The action S of the particle, in units of J-s, at $t = 2$ s is _____. (Give your answer upto two decimal places)

Q.36 A periodic function $f(x)$ of period 2π is defined in the interval $(-\pi < x < \pi)$ as:

$$f(x) = \begin{cases} -1, & -\pi < x < 0 \\ 1, & 0 < x < \pi \end{cases}$$

The appropriate Fourier series expansion for $f(x)$ is

- (A) $f(x) = (4/\pi)[\sin x + (\sin 3x)/3 + (\sin 5x)/5 + \dots]$
 (B) $f(x) = (4/\pi)[\sin x - (\sin 3x)/3 + (\sin 5x)/5 - \dots]$
 (C) $f(x) = (4/\pi)[\cos x + (\cos 3x)/3 + (\cos 5x)/5 + \dots]$
 (D) $f(x) = (4/\pi)[\cos x - (\cos 3x)/3 + (\cos 5x)/5 - \dots]$

Q.37 Atoms, which can be assumed to be hard spheres of radius R , are arranged in an *fcc* lattice with lattice constant a , such that each atom touches its nearest neighbours. Take the center of one of the atoms as the origin. Another atom of radius r (assumed to be hard sphere) is to be accommodated at a position $(0, a/2, 0)$ without distorting the lattice. The maximum value of r/R is _____. (Give your answer upto two decimal places)

Q.38 In an inertial frame of reference S , an observer finds two events occurring at the same time at coordinates $x_1 = 0$ and $x_2 = d$. A different inertial frame S' moves with velocity v with respect to S along the positive x -axis. An observer in S' also notices these two events and finds them to occur at times t'_1 and t'_2 and at positions x'_1 and x'_2 , respectively. If $\Delta t' = t'_2 - t'_1$, $\Delta x' = x'_2 - x'_1$ and

$$\gamma = \frac{1}{\sqrt{1 - \frac{v^2}{c^2}}}, \text{ which of the following statements is true ?}$$

- (A) $\Delta t' = 0, \Delta x' = \gamma d$ (B) $\Delta t' = 0, \Delta x' = d/\gamma$
 (C) $\Delta t' = -\gamma vd/c^2, \Delta x' = \gamma d$ (D) $\Delta t' = -\gamma vd/c^2, \Delta x' = d/\gamma$

- Q.39 The energy vs. wave vector ($E-k$) relationship near the bottom of a band for a solid can be approximated as $E = A(ka)^2 + B(ka)^4$, where the lattice constant $a = 2.1 \text{ \AA}$. The values of A and B are $6.3 \times 10^{-19} \text{ J}$ and $3.2 \times 10^{-20} \text{ J}$, respectively. At the bottom of the conduction band, the ratio of the effective mass of the electron to the mass of free electron is _____. (Give your answer upto two decimal places)
(Take $\hbar = 1.05 \times 10^{-34} \text{ J-s}$, mass of free electron = $9.1 \times 10^{-31} \text{ kg}$)
- Q.40 The electric field component of a plane electromagnetic wave travelling in vacuum is given by $\vec{E}(z,t) = E_0 \cos(kz - \omega t)\hat{i}$. The Poynting vector for the wave is
- (A) $(c\varepsilon_0/2)E_0^2 \cos^2(kz - \omega t)\hat{j}$
 (B) $(c\varepsilon_0/2)E_0^2 \cos^2(kz - \omega t)\hat{k}$
 (C) $c\varepsilon_0 E_0^2 \cos^2(kz - \omega t)\hat{j}$
 (D) $c\varepsilon_0 E_0^2 \cos^2(kz - \omega t)\hat{k}$
- Q.41 Consider a system having three energy levels with energies 0 , 2ε and 3ε , with respective degeneracies of 2 , 2 and 3 . Four bosons of spin zero have to be accommodated in these levels such that the total energy of the system is 10ε . The number of ways in which it can be done is _____.
- Q.42 The Lagrangian of a system is given by $L = \frac{1}{2}ml^2[\dot{\theta}^2 + \sin^2 \theta \dot{\phi}^2] - mgl \cos \theta$, where m, l and g are constants. Which of the following is conserved?
- (A) $\dot{\phi} \sin^2 \theta$ (B) $\dot{\phi} \sin \theta$ (C) $\frac{\dot{\phi}}{\sin \theta}$ (D) $\frac{\dot{\phi}}{\sin^2 \theta}$
- Q.43 Protons and α -particles of equal initial momenta are scattered off a gold foil in a Rutherford scattering experiment. The scattering cross sections for proton on gold and α -particle on gold are σ_p and σ_α respectively. The ratio σ_α/σ_p is _____.

Q.44 For the digital circuit given below, the output X is

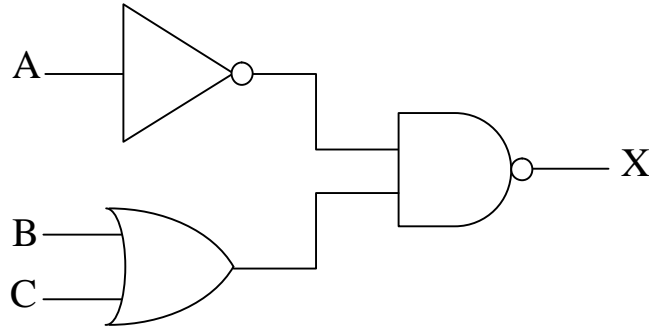

- (A) $\overline{\overline{A} + B \cdot C}$ (B) $\overline{\overline{A} \cdot (B + C)}$
 (C) $\overline{A} \cdot (B + C)$ (D) $A + \overline{(B \cdot C)}$

Q.45 The Fermi energies of two metals X and Y are 5 eV and 7 eV and their Debye temperatures are 170 K and 340 K, respectively. The molar specific heats of these metals at constant volume at low temperatures can be written as $(C_V)_X = \gamma_X T + A_X T^3$ and $(C_V)_Y = \gamma_Y T + A_Y T^3$, where γ and A are constants. Assuming that the thermal effective mass of the electrons in the two metals are same, which of the following is correct?

- (A) $\frac{\gamma_X}{\gamma_Y} = \frac{7}{5}, \frac{A_X}{A_Y} = 8$ (B) $\frac{\gamma_X}{\gamma_Y} = \frac{7}{5}, \frac{A_X}{A_Y} = \frac{1}{8}$
 (C) $\frac{\gamma_X}{\gamma_Y} = \frac{5}{7}, \frac{A_X}{A_Y} = \frac{1}{8}$ (D) $\frac{\gamma_X}{\gamma_Y} = \frac{5}{7}, \frac{A_X}{A_Y} = 8$

Q.46 A two-level system has energies zero and E . The level with zero energy is non-degenerate, while the level with energy E is triply degenerate. The mean energy of a classical particle in this system at a temperature T is

- (A) $\frac{Ee^{-E/k_B T}}{1 + 3e^{-E/k_B T}}$ (B) $\frac{Ee^{-E/k_B T}}{1 + e^{-E/k_B T}}$
 (C) $\frac{3Ee^{-E/k_B T}}{1 + e^{-E/k_B T}}$ (D) $\frac{3Ee^{-E/k_B T}}{1 + 3e^{-E/k_B T}}$

- Q.47 A particle of rest mass M is moving along the positive x -direction. It decays into two photons γ_1 and γ_2 as shown in the figure. The energy of γ_1 is 1 GeV and the energy of γ_2 is 0.82 GeV. The value of M (in units of GeV/c^2) is _____. (Give your answer upto two decimal places)

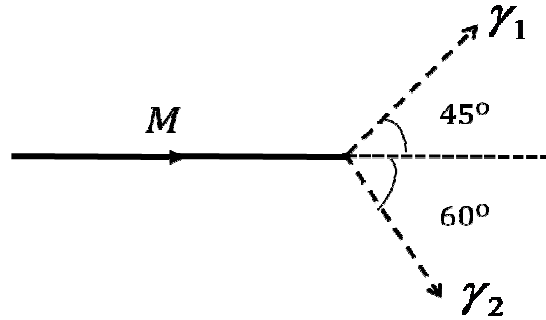

- Q.48 If x and p are the x components of the position and the momentum operators of a particle respectively, the commutator $[x^2, p^2]$ is
- (A) $i\hbar(xp - px)$ (B) $2i\hbar(xp - px)$
 (C) $i\hbar(xp + px)$ (D) $2i\hbar(xp + px)$
- Q.49 The x - y plane is the boundary between free space and a magnetic material with relative permeability μ_r . The magnetic field in the free space is $B_x \hat{i} + B_z \hat{k}$. The magnetic field in the magnetic material is
- (A) $B_x \hat{i} + B_z \hat{k}$ (B) $B_x \hat{i} + \mu_r B_z \hat{k}$
 (C) $\frac{1}{\mu_r} B_x \hat{i} + B_z \hat{k}$ (D) $\mu_r B_x \hat{i} + B_z \hat{k}$
- Q.50 Let $|l, m\rangle$ be the simultaneous eigenstates of L^2 and L_z . Here \vec{L} is the angular momentum operator with Cartesian components (L_x, L_y, L_z) , l is the angular momentum quantum number and m is the azimuthal quantum number. The value of $\langle 1, 0 | (L_x + iL_y) | 1, -1 \rangle$ is
- (A) 0 (B) \hbar (C) $\sqrt{2}\hbar$ (D) $\sqrt{3}\hbar$
- Q.51 For the parity operator P , which of the following statements is NOT true?
- (A) $P^\dagger = P$ (B) $P^2 = -P$ (C) $P^2 = I$ (D) $P^\dagger = P^{-1}$

- Q.52 For the transistor shown in the figure, assume $V_{BE} = 0.7 \text{ V}$ and $\beta_{dc} = 100$. If $V_{in} = 5 \text{ V}$, V_{out} (in Volts) is _____. (Give your answer upto one decimal place)

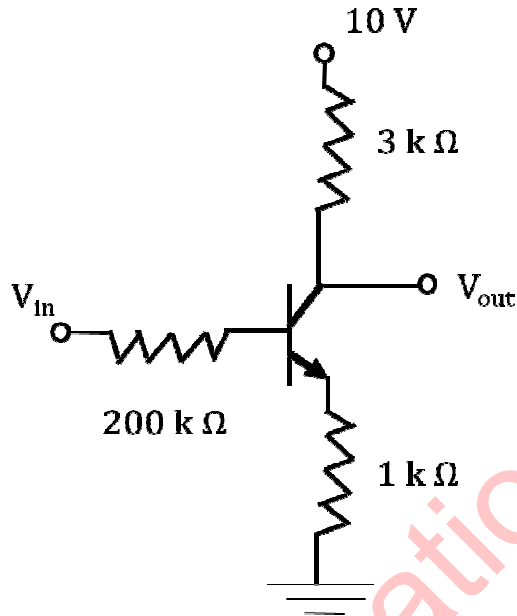

- Q.53 The state of a system is given by

$$|\psi\rangle = |\phi_1\rangle + 2|\phi_2\rangle + 3|\phi_3\rangle$$

where $|\phi_1\rangle$, $|\phi_2\rangle$ and $|\phi_3\rangle$ form an orthonormal set. The probability of finding the system in the state $|\phi_2\rangle$ is _____. (Give your answer upto two decimal places)

- Q.54 According to the nuclear shell model, the respective ground state spin-parity values of $^{15}_8\text{O}$ and $^{17}_8\text{O}$ nuclei are

(A) $\frac{1}{2}^+$, $\frac{1}{2}^-$

(B) $\frac{1}{2}^-$, $\frac{5}{2}^+$

(C) $\frac{3}{2}^-$, $\frac{5}{2}^+$

(D) $\frac{3}{2}^-$, $\frac{1}{2}^-$

- Q.55 A particle of mass m and energy E , moving in the positive x direction, is incident on a step potential at $x = 0$, as indicated in the figure. The height of the potential is V_0 , where $V_0 > E$. At $x = x_0$, where $x_0 > 0$, the probability of finding the electron is $1/e$ times the probability of finding it at $x = 0$. If $\alpha = \sqrt{\frac{2m(V_0 - E)}{\hbar^2}}$, the value of x_0 is

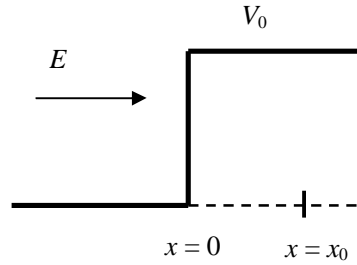

(A) $\frac{2}{\alpha}$

(B) $\frac{1}{\alpha}$

(C) $\frac{1}{2\alpha}$

(D) $\frac{1}{4\alpha}$

END OF THE QUESTION PAPER

Q. No	Type	Section	Key	Marks
1	MCQ	GA	B	1
2	MCQ	GA	A	1
3	MCQ	GA	D	1
4	MCQ	GA	C	1
5	MCQ	GA	B	1
6	MCQ	GA	C	2
7	MCQ	GA	C	2
8	MCQ	GA	C	2
9	MCQ	GA	A	2
10	MCQ	GA	C	2
1	MCQ	PH	D	1
2	MCQ	PH	C	1
3	MCQ	PH	C	1
4	NAT	PH	0 : 0	1
5	MCQ	PH	A	1
6	MCQ	PH	B	1
7	NAT	PH	4 : 4	1
8	NAT	PH	0.25 : 0.25	1
9	NAT	PH	0.5 : 0.5	1
10	MCQ	PH	A	1
11	NAT	PH	2 : 2	1
12	MCQ	PH	A	1
13	NAT	PH	9 : 9	1
14	MCQ	PH	C	1
15	MCQ	PH	A	1
16	MCQ	PH	B	1
17	NAT	PH	1.72 : 1.74	1
18	NAT	PH	400 : 400	1
19	NAT	PH	2.41 : 2.49	1
20	MCQ	PH	B	1
21	MCQ	PH	B	1
22	MCQ	PH	A	1
23	NAT	PH	2 : 2	1
24	NAT	PH	2 : 2	1
25	MCQ	PH	C	1
26	MCQ	PH	D	2
27	NAT	PH	12 : 12 ; 6 : 6	2
28	MCQ	PH	C	2
29	MCQ	PH	B	2
30	NAT	PH	24 : 24	2
31	NAT	PH	80 : 80	2
32	MCQ	PH	D	2
33	MCQ	PH	B	2
34	MCQ	PH	C	2
35	NAT	PH	26.65 : 26.68	2
36	MCQ	PH	A	2
37	NAT	PH	0.40 : 0.42	2
38	MCQ	PH	C	2
39	NAT	PH	0.20 : 0.24	2

40	MCQ	PH	D	2
41	NAT	PH	18 : 18	2
42	MCQ	PH	A	2
43	NAT	PH	4 : 4	2
44	MCQ	PH	B	2
45	MCQ	PH	A	2
46	MCQ	PH	D	2
47	NAT	PH	1.40 : 1.45	2
48	MCQ	PH	D	2
49	MCQ	PH	D	2
50	MCQ	PH	C	2
51	MCQ	PH	B	2
52	NAT	PH	5.5 : 5.9	2
53	NAT	PH	0.27 : 0.29	2
54	MCQ	PH	B	2
55	MCQ	PH	C	2

www.sakshieducation.com