

Q. 1 – Q. 5 carry one mark each.

Q.1 Based on the given statements, select the appropriate option with respect to grammar and usage.

Statements

- (i) The height of Mr. **X** is 6 feet.
(ii) The height of Mr. **Y** is 5 feet.

- (A) Mr. **X** is longer than Mr. **Y**.
(B) Mr. **X** is more elongated than Mr. **Y**.
(C) Mr. **X** is taller than Mr. **Y**.
(D) Mr. **X** is lengthier than Mr. **Y**.

Q.2 The students _____ the teacher on teachers' day for twenty years of dedicated teaching.

- (A) facilitated (B) felicitated (C) fantasized (D) facillitated

Q.3 After India's cricket world cup victory in 1985, Shrotria who was playing both tennis and cricket till then, decided to concentrate only on cricket. And the rest is history.

What does the underlined phrase mean in this context?

- (A) history will rest in peace (B) rest is recorded in history books
(C) rest is well known (D) rest is archaic

Q.4 Given $(9 \text{ inches})^{\frac{1}{2}} = (0.25 \text{ yards})^{\frac{1}{2}}$, which one of the following statements is **TRUE**?

- (A) 3 inches = 0.5 yards (B) 9 inches = 1.5 yards
(C) 9 inches = 0.25 yards (D) 81 inches = 0.0625 yards

Q.5 **S**, **M**, **E** and **F** are working in shifts in a team to finish a project. **M** works with twice the efficiency of others but for half as many days as **E** worked. **S** and **M** have 6 hour shifts in a day, whereas **E** and **F** have 12 hours shifts. What is the ratio of contribution of **M** to contribution of **E** in the project?

- (A) 1:1 (B) 1:2 (C) 1:4 (D) 2:1

Q. 6 – Q. 10 carry two marks each.

Q.6 The Venn diagram shows the preference of the student population for leisure activities.

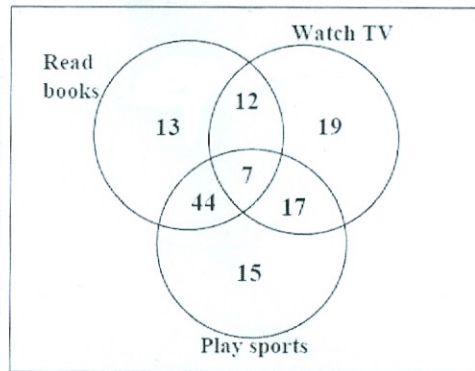

From the data given, the number of students who like to read books or play sports is _____.

- (A) 44 (B) 51 (C) 79 (D) 108

Q.7 Social science disciplines were in existence in an amorphous form until the colonial period when they were institutionalized. In varying degrees, they were intended to further the colonial interest. In the time of globalization and the economic rise of postcolonial countries like India, conventional ways of knowledge production have become obsolete.

Which of the following can be logically inferred from the above statements?

- (i) Social science disciplines have become obsolete.
- (ii) Social science disciplines had a pre-colonial origin.
- (iii) Social science disciplines always promote colonialism.
- (iv) Social science must maintain disciplinary boundaries.

- (A) (ii) only (B) (i) and (iii) only
(C) (ii) and (iv) only (D) (iii) and (iv) only

Q.8 Two and a quarter hours back, when seen in a mirror, the reflection of a wall clock without number markings seemed to show 1:30. What is the actual current time shown by the clock?

- (A) 8:15 (B) 11:15 (C) 12:15 (D) 12:45

Q.9 **M** and **N** start from the same location. **M** travels 10 km East and then 10 km North-East. **N** travels 5 km South and then 4 km South-East. What is the shortest distance (in km) between **M** and **N** at the end of their travel?

- (A) 18.60 (B) 22.50 (C) 20.61 (D) 25.00

- Q.10 A wire of length 340 mm is to be cut into two parts. One of the parts is to be made into a square and the other into a rectangle where sides are in the ratio of 1:2. What is the length of the side of the square (in mm) such that the combined area of the square and the rectangle is a **MINIMUM**?
- (A) 30 (B) 40 (C) 120 (D) 180

END OF THE QUESTION PAPER

www.sakshieducation.com

Q. 1 – Q. 25 carry one mark each.

Q.1 A real square matrix A is called skew-symmetric if

- (A) $A^T = A$
- (B) $A^T = A^{-1}$
- (C) $A^T = -A$
- (D) $A^T = A + A^{-1}$

Q.2 $\lim_{x \rightarrow 0} \frac{\log_e(1+4x)}{e^{3x}-1}$ is equal to

- (A) 0
- (B) $\frac{1}{12}$
- (C) $\frac{4}{3}$
- (D) 1

Q.3 Solutions of Laplace's equation having continuous second-order partial derivatives are called

- (A) biharmonic functions
- (B) harmonic functions
- (C) conjugate harmonic functions
- (D) error functions

Q.4 The area (in percentage) under standard normal distribution curve of random variable Z within limits from -3 to $+3$ is _____

Q.5 The root of the function $f(x) = x^3 + x - 1$ obtained after first iteration on application of Newton-Raphson scheme using an initial guess of $x_0 = 1$ is

- (A) 0.682
- (B) 0.686
- (C) 0.750
- (D) 1.000

Q.6 A force F is acting on a bent bar which is clamped at one end as shown in the figure.

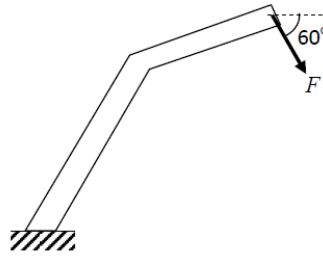

The CORRECT free body diagram is

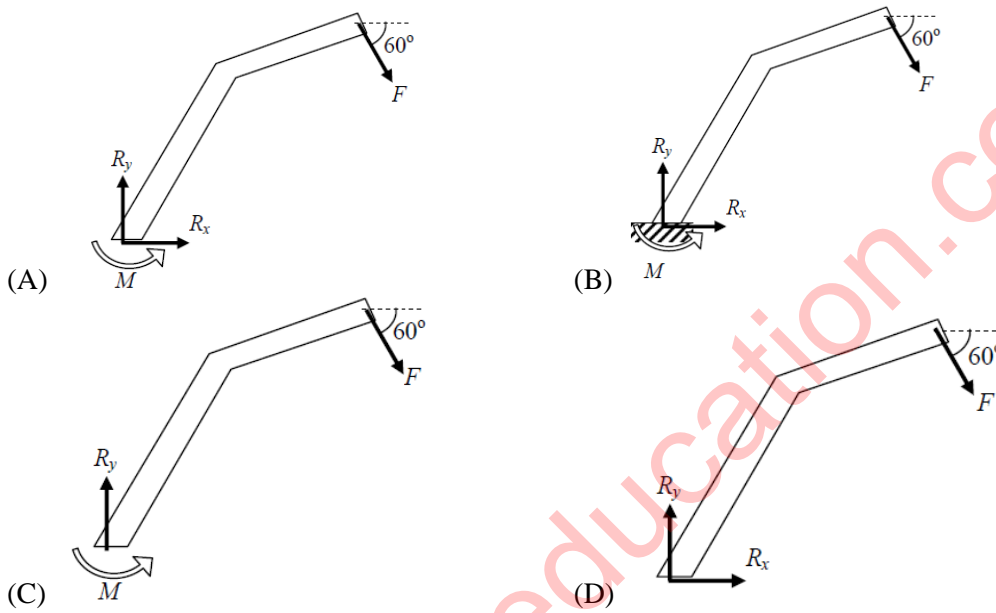

Q.7 The cross-sections of two solid bars made of the same material are shown in the figure. The square cross-section has flexural (bending) rigidity I_1 , while the circular cross-section has flexural rigidity I_2 . Both sections have the same cross-sectional area. The ratio I_1/I_2 is

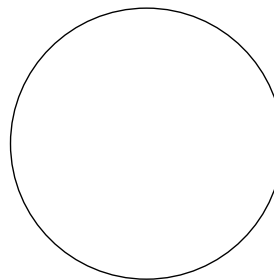

(A) $1/\pi$

(B) $2/\pi$

(C) $\pi/3$

(D) $\pi/6$

- Q.8 The state of stress at a point on an element is shown in figure (a). The same state of stress is shown in another coordinate system in figure (b).

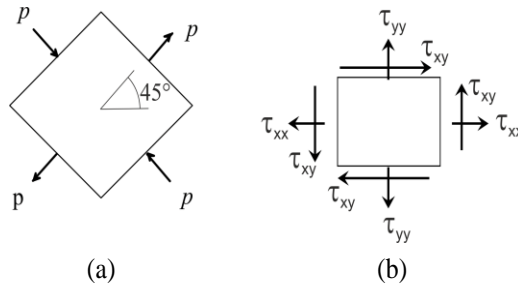

The components $(\tau_{xx}, \tau_{yy}, \tau_{xy})$ are given by

- (A) $(p/\sqrt{2}, -p/\sqrt{2}, 0)$ (B) $(0, 0, p)$
 (C) $(p, -p, p/\sqrt{2})$ (D) $(0, 0, p/\sqrt{2})$
- Q.9 A rigid link PQ is undergoing plane motion as shown in the figure (V_P and V_Q are non-zero). V_{QP} is the relative velocity of point Q with respect to point P .

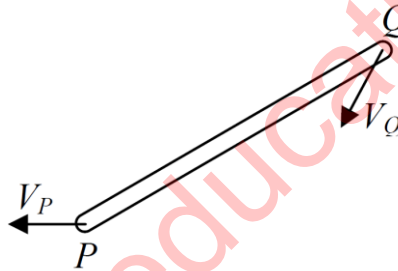

Which one of the following is TRUE?

- (A) V_{QP} has components along and perpendicular to PQ
 (B) V_{QP} has only one component directed from P to Q
 (C) V_{QP} has only one component directed from Q to P
 (D) V_{QP} has only one component perpendicular to PQ
- Q.10 The number of degrees of freedom in a planar mechanism having n links and j simple hinge joints is
- (A) $3(n - 3) - 2j$
 (B) $3(n - 1) - 2j$
 (C) $3n - 2j$
 (D) $2j - 3n + 4$
- Q.11 The static deflection of a spring under gravity, when a mass of 1 kg is suspended from it, is 1 mm. Assume the acceleration due to gravity $g = 10 \text{ m/s}^2$. The natural frequency of this spring-mass system (in rad/s) is _____
- Q.12 Which of the bearings given below SHOULD NOT be subjected to a thrust load?
- (A) Deep groove ball bearing
 (B) Angular contact ball bearing
 (C) Cylindrical (straight) roller bearing
 (D) Single row tapered roller bearing

- Q.13 A channel of width 450 mm branches into two sub-channels having width 300 mm and 200 mm as shown in figure. If the volumetric flow rate (taking unit depth) of an incompressible flow through the main channel is $0.9 \text{ m}^3/\text{s}$ and the velocity in the sub-channel of width 200 mm is 3 m/s, the velocity in the sub-channel of width 300 mm is _____ m/s.

Assume both inlet and outlet to be at the same elevation.

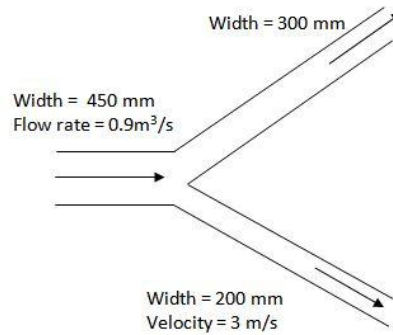

- Q.14 For a certain two-dimensional incompressible flow, velocity field is given by $2xy \hat{i} - y^2 \hat{j}$. The streamlines for this flow are given by the family of curves
- (A) $x^2 y^2 = \text{constant}$ (B) $xy^2 = \text{constant}$
 (C) $2xy - y^2 = \text{constant}$ (D) $xy = \text{constant}$
- Q.15 Steady one-dimensional heat conduction takes place across the faces 1 and 3 of a composite slab consisting of slabs A and B in perfect contact as shown in the figure, where k_A, k_B denote the respective thermal conductivities. Using the data as given in the figure, the interface temperature T_2 (in $^\circ\text{C}$) is _____

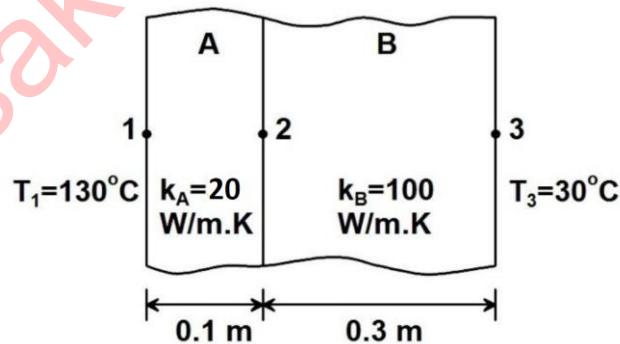

- Q.16 Grashof number signifies the ratio of
- (A) inertia force to viscous force
 (B) buoyancy force to viscous force
 (C) buoyancy force to inertia force
 (D) inertia force to surface tension force

- Q.17 The INCORRECT statement about the characteristics of critical point of a pure substance is that
- (A) there is no constant temperature vaporization process
 (B) it has point of inflection with zero slope
 (C) the ice directly converts from solid phase to vapor phase
 (D) saturated liquid and saturated vapor states are identical
- Q.18 For a heat exchanger, ΔT_{max} is the maximum temperature difference and ΔT_{min} is the minimum temperature difference between the two fluids. $LMTD$ is the log mean temperature difference. C_{min} and C_{max} are the minimum and the maximum heat capacity rates. The maximum possible heat transfer (Q_{max}) between the two fluids is
- (A) $C_{min} LMTD$ (B) $C_{min} \Delta T_{max}$ (C) $C_{max} \Delta T_{max}$ (D) $C_{max} \Delta T_{min}$
- Q.19 The blade and fluid velocities for an axial turbine are as shown in the figure.

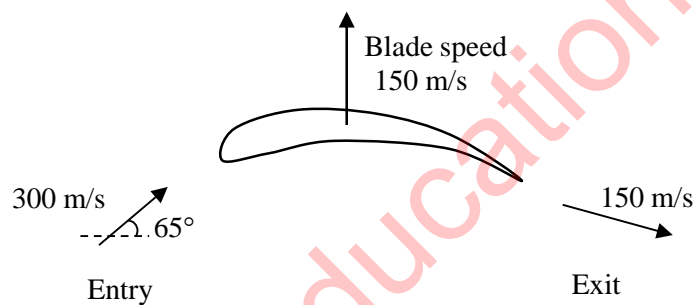

The magnitude of absolute velocity at entry is 300 m/s at an angle of 65° to the axial direction, while the magnitude of the absolute velocity at exit is 150 m/s. The exit velocity vector has a component in the downward direction. Given that the axial (horizontal) velocity is the same at entry and exit, the specific work (in kJ/kg) is _____

- Q.20 Engineering strain of a mild steel sample is recorded as 0.100%. The true strain is
- (A) 0.010% (B) 0.055% (C) 0.099% (D) 0.101%
- Q.21 Equal amounts of a liquid metal at the same temperature are poured into three moulds made of steel, copper and aluminum. The shape of the cavity is a cylinder with 15 mm diameter. The size of the moulds are such that the outside temperature of the moulds do not increase appreciably beyond the atmospheric temperature during solidification. The sequence of solidification in the mould from the fastest to slowest is
- (Thermal conductivities of steel, copper and aluminum are 60.5, 401 and 237 W/m-K, respectively. Specific heats of steel, copper and aluminum are 434, 385 and 903 J/kg-K, respectively. Densities of steel, copper and aluminum are 7854, 8933 and 2700 kg/m³, respectively.)
- (A) Copper - Steel - Aluminum
 (B) Aluminum - Steel - Copper
 (C) Copper - Aluminum - Steel
 (D) Steel - Copper - Aluminum

Q.22 In a wire-cut EDM process the necessary conditions that have to be met for making a successful cut are that

- (A) wire and sample are electrically non-conducting
- (B) wire and sample are electrically conducting
- (C) wire is electrically conducting and sample is electrically non-conducting
- (D) sample is electrically conducting and wire is electrically non-conducting

Q.23 Internal gears are manufactured by

- (A) hobbing
- (B) shaping with pinion cutter
- (C) shaping with rack cutter
- (D) milling

Q.24 Match the following part programming codes with their respective functions

Part Programming Codes	Functions
P. G01	I. Spindle stop
Q. G03	II. Spindle rotation, clockwise
R. M03	III. Circular interpolation, anticlockwise
S. M05	IV. Linear interpolation

- (A) P – II, Q – I, R – IV, S – III
- (B) P – IV, Q – II, R – III, S – I
- (C) P – IV, Q – III, R – II, S – I
- (D) P – III, Q – IV, R – II, S – I

Q.25 In PERT chart, the activity time distribution is

- (A) Normal
- (B) Binomial
- (C) Poisson
- (D) Beta

Q. 26 – Q. 55 carry two marks each.

Q.26

The number of linearly independent eigenvectors of matrix $A = \begin{bmatrix} 2 & 1 & 0 \\ 0 & 2 & 0 \\ 0 & 0 & 3 \end{bmatrix}$ is _____

Q.27 The value of the line integral $\oint_C \vec{F} \cdot \vec{r}' ds$, where C is a circle of radius $\frac{4}{\sqrt{\pi}}$ units is _____

Here, $\vec{F}(x, y) = y \hat{i} + 2x \hat{j}$ and \vec{r}' is the **UNIT** tangent vector on the curve C at an arc length s from a reference point on the curve. \hat{i} and \hat{j} are the basis vectors in the x - y Cartesian reference. In evaluating the line integral, the curve has to be traversed in the counter-clockwise direction.

Q.28 $\lim_{x \rightarrow \infty} \sqrt{x^2 + x - 1} - x$ is

- (A) 0 (B) ∞ (C) $1/2$ (D) $-\infty$

Q.29 Three cards were drawn from a pack of 52 cards. The probability that they are a king, a queen, and a jack is

- (A) $\frac{16}{5525}$ (B) $\frac{64}{2197}$ (C) $\frac{3}{13}$ (D) $\frac{8}{16575}$

Q.30 An inextensible massless string goes over a frictionless pulley. Two weights of 100 N and 200 N are attached to the two ends of the string. The weights are released from rest, and start moving due to gravity. The tension in the string (in N) is _____

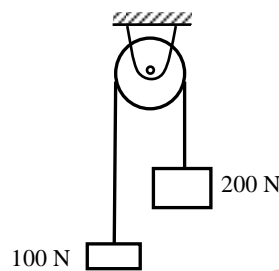

Q.31 A circular disc of radius 100 mm and mass 1 kg, initially at rest at position A, rolls without slipping down a curved path as shown in figure. The speed v of the disc when it reaches position B is _____ m/s.

Acceleration due to gravity $g = 10 \text{ m/s}^2$.

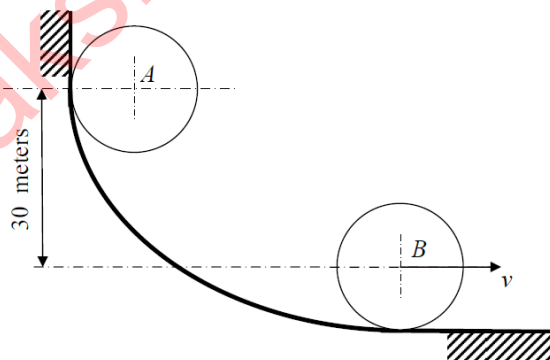

- Q.32 A rigid rod (AB) of length $L = \sqrt{2}$ m is undergoing translational as well as rotational motion in the x - y plane (see the figure). The point A has the velocity $V_1 = \hat{i} + 2\hat{j}$ m/s. The end B is constrained to move only along the x direction.

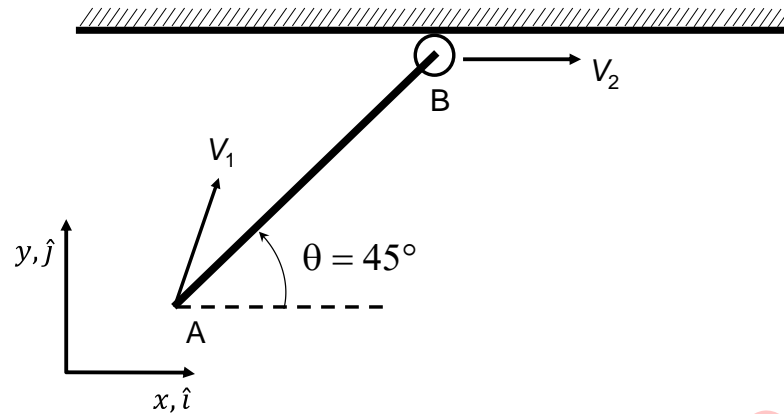

The magnitude of the velocity V_2 (in m/s) at the end B is _____

- Q.33 A square plate of dimension $L \times L$ is subjected to a uniform pressure load $p = 250$ MPa on its edges as shown in the figure. Assume plane stress conditions. The Young's modulus $E = 200$ GPa.

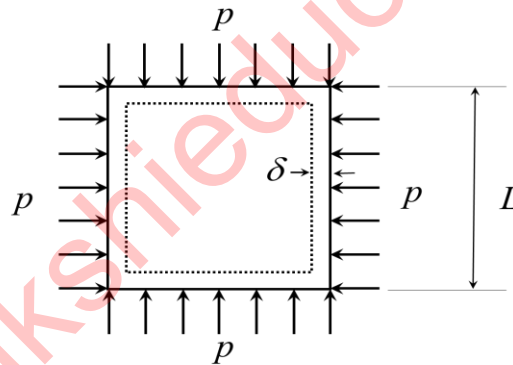

The deformed shape is a square of dimension $L - 2\delta$. If $L = 2$ m and $\delta = 0.001$ m, the Poisson's ratio of the plate material is _____

- Q.34 Two circular shafts made of same material, one solid (S) and one hollow (H), have the same length and polar moment of inertia. Both are subjected to same torque. Here, θ_S is the twist and τ_S is the maximum shear stress in the solid shaft, whereas θ_H is the twist and τ_H is the maximum shear stress in the hollow shaft. Which one of the following is TRUE?

- (A) $\theta_S = \theta_H$ and $\tau_S = \tau_H$
- (B) $\theta_S > \theta_H$ and $\tau_S > \tau_H$
- (C) $\theta_S < \theta_H$ and $\tau_S < \tau_H$
- (D) $\theta_S = \theta_H$ and $\tau_S < \tau_H$

- Q.35 A beam of length L is carrying a uniformly distributed load w per unit length. The flexural rigidity of the beam is EI . The reaction at the simple support at the right end is

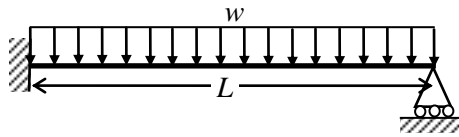

- (A) $\frac{wL}{2}$ (B) $\frac{3wL}{8}$ (C) $\frac{wL}{4}$ (D) $\frac{wL}{8}$
- Q.36 Two masses m are attached to opposite sides of a rigid rotating shaft in the vertical plane. Another pair of equal masses m_1 is attached to the opposite sides of the shaft in the vertical plane as shown in figure. Consider $m = 1$ kg, $e = 50$ mm, $e_1 = 20$ mm, $b = 0.3$ m, $a = 2$ m and $a_1 = 2.5$ m. For the system to be dynamically balanced, m_1 should be _____ kg.

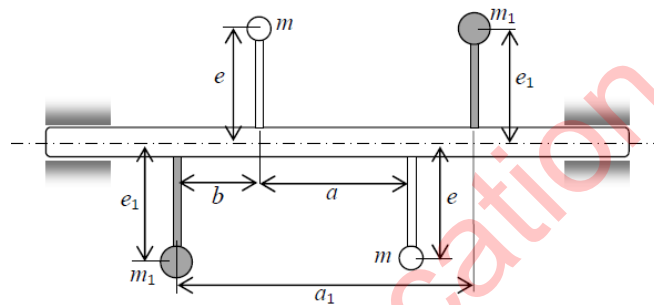

- Q.37 A single degree of freedom spring-mass system is subjected to a harmonic force of constant amplitude. For an excitation frequency of $\sqrt{\frac{3k}{m}}$, the ratio of the amplitude of steady state response to the static deflection of the spring is _____

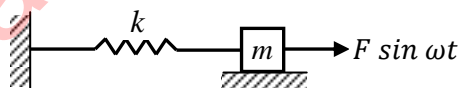

- Q.38 A bolted joint has four bolts arranged as shown in figure. The cross sectional area of each bolt is 25 mm^2 . A torque $T = 200 \text{ N-m}$ is acting on the joint. Neglecting friction due to clamping force, maximum shear stress in a bolt is _____ MPa.

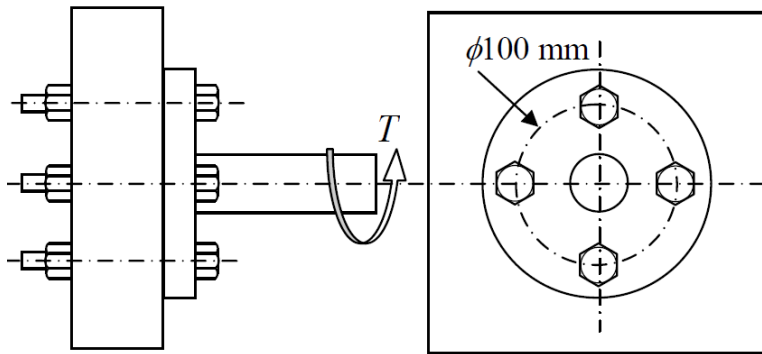

- Q.39 Consider a fully developed steady laminar flow of an incompressible fluid with viscosity μ through a circular pipe of radius R . Given that the velocity at a radial location of $R/2$ from the centerline of the pipe is U_1 , the shear stress at the wall is $K\mu U_1/R$, where K is _____

- Q.40 The water jet exiting from a stationary tank through a circular opening of diameter 300 mm impinges on a rigid wall as shown in the figure. Neglect all minor losses and assume the water level in the tank to remain constant. The net horizontal force experienced by the wall is _____ kN.

Density of water is 1000 kg/m^3 .

Acceleration due to gravity $g = 10 \text{ m/s}^2$.

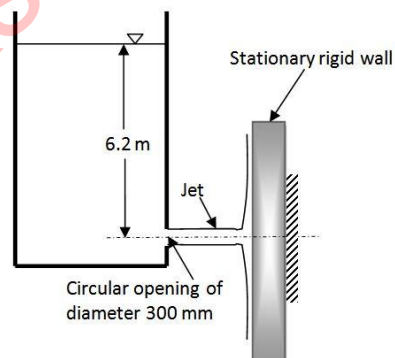

Q.41

For a two-dimensional flow, the velocity field is $\vec{u} = \frac{x}{x^2 + y^2} \hat{i} + \frac{y}{x^2 + y^2} \hat{j}$, where \hat{i} and \hat{j} are the basis vectors in the x - y Cartesian coordinate system. Identify the **CORRECT** statements from below.

- (1) The flow is incompressible.
 (2) The flow is unsteady.

(3) y -component of acceleration, $a_y = \frac{-y}{(x^2 + y^2)^2}$

(4) x -component of acceleration, $a_x = \frac{-(x+y)}{(x^2 + y^2)^2}$

(A) (2) and (3)

(B) (1) and (3)

(C) (1) and (2)

(D) (3) and (4)

Q.42

Two large parallel plates having a gap of 10 mm in between them are maintained at temperatures $T_1 = 1000$ K and $T_2 = 400$ K. Given emissivity values, $\epsilon_1 = 0.5$, $\epsilon_2 = 0.25$ and Stefan-Boltzmann constant $\sigma = 5.67 \times 10^{-8}$ W/m²-K⁴, the heat transfer between the plates (in kW/m²) is _____

Q.43

A cylindrical steel rod, 0.01 m in diameter and 0.2 m in length is first heated to 750 °C and then immersed in a water bath at 100 °C. The heat transfer coefficient is 250 W/m²-K. The density, specific heat and thermal conductivity of steel are $\rho = 7801$ kg/m³, $c = 473$ J/kg-K, and $k = 43$ W/m-K, respectively. The time required for the rod to reach 300 °C is _____ seconds.

Q.44

Steam at an initial enthalpy of 100 kJ/kg and inlet velocity of 100 m/s, enters an insulated horizontal nozzle. It leaves the nozzle at 200 m/s. The exit enthalpy (in kJ/kg) is _____

Q.45

In a mixture of dry air and water vapor at a total pressure of 750 mm of Hg, the partial pressure of water vapor is 20 mm of Hg. The humidity ratio of the air in grams of water vapor per kg of dry air (g_w/kg_{da}) is _____

Q.46

In a 3-stage air compressor, the inlet pressure is p_1 , discharge pressure is p_4 and the intermediate pressures are p_2 and p_3 ($p_2 < p_3$). The total pressure ratio of the compressor is 10 and the pressure ratios of the stages are equal. If $p_1 = 100$ kPa, the value of the pressure p_3 (in kPa) is _____

- Q.47 In the vapour compression cycle shown in the figure, the evaporating and condensing temperatures are 260 K and 310 K, respectively. The compressor takes in liquid-vapour mixture (state 1) and isentropically compresses it to a dry saturated vapour condition (state 2). The specific heat of the liquid refrigerant is 4.8 kJ/kg-K and may be treated as constant. The enthalpy of evaporation for the refrigerant at 310 K is 1054 kJ/kg.

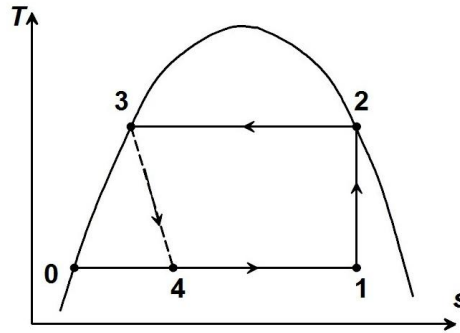

The difference between the enthalpies at state points 1 and 0 (in kJ/kg) is _____

- Q.48 Spot welding of two steel sheets each 2 mm thick is carried out successfully by passing 4 kA of current for 0.2 seconds through the electrodes. The resulting weld nugget formed between the sheets is 5 mm in diameter. Assuming cylindrical shape for the nugget, the thickness of the nugget is _____ mm.

Latent heat of fusion for steel	1400 kJ/kg
Effective resistance of the weld joint	200 $\mu\Omega$
Density of steel	8000 kg/m ³

- Q.49 For an orthogonal cutting operation, tool material is HSS, rake angle is 22° , chip thickness is 0.8 mm, speed is 48 m/min and feed is 0.4 mm/rev. The shear plane angle (in degrees) is
- (A) 19.24 (B) 29.70 (C) 56.00 (D) 68.75
- Q.50 In a sheet metal of 2 mm thickness a hole of 10 mm diameter needs to be punched. The yield strength in tension of the sheet material is 100 MPa and its ultimate shear strength is 80 MPa. The force required to punch the hole (in kN) is _____
- Q.51 In a single point turning operation with cemented carbide tool and steel work piece, it is found that the Taylor's exponent is 0.25. If the cutting speed is reduced by 50% then the tool life changes by _____ times.

- Q.52 Two optically flat plates of glass are kept at a small angle θ as shown in the figure. Monochromatic light is incident vertically.

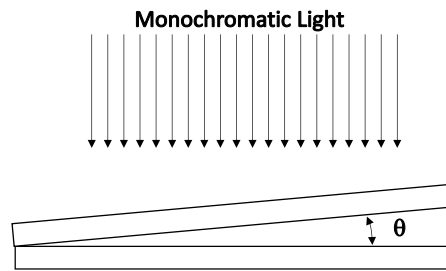

If the wavelength of light used to get a fringe spacing of 1 mm is 450 nm, the wavelength of light (in nm) to get a fringe spacing of 1.5 mm is _____

- Q.53 A point P (1, 3, -5) is translated by $2\hat{i} + 3\hat{j} - 4\hat{k}$ and then rotated counter clockwise by 90° about the z-axis. The new position of the point is
- (A) (-6, 3, -9) (B) (-6, -3, -9) (C) (6, 3, -9) (D) (6, 3, 9)
- Q.54 The demand for a two-wheeler was 900 units and 1030 units in April 2015 and May 2015, respectively. The forecast for the month of April 2015 was 850 units. Considering a smoothing constant of 0.6, the forecast for the month of June 2015 is
- (A) 850 units (B) 927 units (C) 965 units (D) 970 units
- Q.55 A firm uses a turning center, a milling center and a grinding machine to produce two parts. The table below provides the machining time required for each part and the maximum machining time available on each machine. The profit per unit on parts I and II are Rs. 40 and Rs. 100, respectively. The maximum profit per week of the firm is Rs. _____

Type of machine	Machining time required for the machine part (minutes)		Maximum machining time available per week (minutes)
	I	II	
Turning Center	12	6	6000
Milling Center	4	10	4000
Grinding Machine	2	3	1800

END OF THE QUESTION PAPER

Q. No	Type	Section	Key	Marks
1	MCQ	GA	C	1
2	MCQ	GA	B	1
3	MCQ	GA	C	1
4	MCQ	GA	C	1
5	MCQ	GA	B	1
6	MCQ	GA	D	2
7	MCQ	GA	A	2
8	MCQ	GA	D	2
9	MCQ	GA	C	2
10	MCQ	GA	B	2
1	MCQ	ME-3	C	1
2	MCQ	ME-3	C	1
3	MCQ	ME-3	B	1
4	NAT	ME-3	99.6 : 99.8	1
5	MCQ	ME-3	C	1
6	MCQ	ME-3	A	1
7	MCQ	ME-3	C	1
8	MCQ	ME-3	B	1
9	MCQ	ME-3	D	1
10	MCQ	ME-3	B	1
11	NAT	ME-3	99 : 101	1
12	MCQ	ME-3	C	1
13	NAT	ME-3	0.99 : 1.01	1
14	MCQ	ME-3	B	1
15	NAT	ME-3	67 : 68	1
16	MCQ	ME-3	B	1
17	MCQ	ME-3	C	1
18	MCQ	ME-3	B	1
19	NAT	ME-3	50 : 54	1
20	MCQ	ME-3	C	1
21	MCQ	ME-3	C	1
22	MCQ	ME-3	B	1
23	MCQ	ME-3	B	1
24	MCQ	ME-3	C	1
25	MCQ	ME-3	D	1
26	NAT	ME-3	2 : 2	2
27	NAT	ME-3	15.9 : 16.1	2
28	MCQ	ME-3	C	2
29	MCQ	ME-3	A	2
30	NAT	ME-3	130 : 135	2
31	NAT	ME-3	19.9 : 20.1	2
32	NAT	ME-3	2.9 : 3.1	2
33	NAT	ME-3	0.18 : 0.22	2
34	MCQ	ME-3	D	2
35	MCQ	ME-3	B	2
36	NAT	ME-3	1.9 : 2.1	2
37	NAT	ME-3	0.49 : 0.51	2
38	NAT	ME-3	39.9 : 40.1	2
39	NAT	ME-3	2.6 : 2.7	2

40	NAT	ME-3	8.76 : 8.78	2
41	MCQ	ME-3	B	2
42	NAT	ME-3	10.9 : 11.2	2
43	NAT	ME-3	42 : 45	2
44	NAT	ME-3	84 : 86	2
45	NAT	ME-3	16.9 : 17.1	2
46	NAT	ME-3	460 : 470	2
47	NAT	ME-3	1095 : 1130	2
48	NAT	ME-3	2.85 : 2.95	2
49	MCQ	ME-3	B	2
50	NAT	ME-3	4.9 : 5.1	2
51	NAT	ME-3	14 : 18	2
52	NAT	ME-3	674 : 676	2
53	MCQ	ME-3	A	2
54	MCQ	ME-3	D	2
55	NAT	ME-3	39000 : 41000	2

www.sakshieducation.com