

**Q. 1 – Q. 5 carry one mark each.**

Q.1 Which of the following is **CORRECT** with respect to grammar and usage?

Mount Everest is \_\_\_\_\_.

- (A) the highest peak in the world
- (B) highest peak in the world
- (C) one of highest peak in the world
- (D) one of the highest peak in the world

Q.2 The policeman asked the victim of a theft, "What did you \_\_\_\_\_?"

- (A) loose
- (B) lose
- (C) loss
- (D) louse

Q.3 Despite the new medicine's \_\_\_\_\_ in treating diabetes, it is not \_\_\_\_\_ widely.

- (A) effectiveness --- prescribed
- (B) availability --- used
- (C) prescription --- available
- (D) acceptance --- proscribed

Q.4 In a huge pile of apples and oranges, both ripe and unripe mixed together, 15% are unripe fruits. Of the unripe fruits, 45% are apples. Of the ripe ones, 66% are oranges. If the pile contains a total of 5692000 fruits, how many of them are apples?

- (A) 2029198
- (B) 2467482
- (C) 2789080
- (D) 3577422

Q.5 Michael lives 10 km away from where I live. Ahmed lives 5 km away and Susan lives 7 km away from where I live. Arun is farther away than Ahmed but closer than Susan from where I live. From the information provided here, what is one possible distance (in km) at which I live from Arun's place?

- (A) 3.00
- (B) 4.99
- (C) 6.02
- (D) 7.01

**Q. 6 – Q. 10 carry two marks each.**

Q.6 A person moving through a tuberculosis prone zone has a 50% probability of becoming infected. However, only 30% of infected people develop the disease. What percentage of people moving through a tuberculosis prone zone remains infected but does not show symptoms of disease?

- (A) 15
- (B) 33
- (C) 35
- (D) 37

- Q.7 In a world filled with uncertainty, he was glad to have many good friends. He had always assisted them in times of need and was confident that they would reciprocate. However, the events of the last week proved him wrong.

Which of the following inference(s) is/are logically valid and can be inferred from the above passage?

- (i) His friends were always asking him to help them.
- (ii) He felt that when in need of help, his friends would let him down.
- (iii) He was sure that his friends would help him when in need.
- (iv) His friends did not help him last week.

- (A) (i) and (ii)                      (B) (iii) and (iv)                      (C) (iii) only                      (D) (iv) only

- Q.8 Leela is older than her cousin Pavithra. Pavithra's brother Shiva is older than Leela. When Pavithra and Shiva are visiting Leela, all three like to play chess. Pavithra wins more often than Leela does.

Which one of the following statements must be **TRUE** based on the above?

- (A) When Shiva plays chess with Leela and Pavithra, he often loses.
- (B) Leela is the oldest of the three.
- (C) Shiva is a better chess player than Pavithra.
- (D) Pavithra is the youngest of the three.

- Q.9 If  $q^{-a} = \frac{1}{r}$  and  $r^{-b} = \frac{1}{s}$  and  $s^{-c} = \frac{1}{q}$ , the value of  $abc$  is \_\_\_\_.

- (A)  $(rqs)^{-1}$                       (B) 0                      (C) 1                      (D)  $r+q+s$

- Q.10 **P**, **Q**, **R** and **S** are working on a project. **Q** can finish the task in 25 days, working alone for 12 hours a day. **R** can finish the task in 50 days, working alone for 12 hours per day. **Q** worked 12 hours a day but took sick leave in the beginning for two days. **R** worked 18 hours a day on all days. What is the ratio of work done by **Q** and **R** after 7 days from the start of the project?

- (A) 10:11                      (B) 11:10                      (C) 20:21                      (D) 21:20

**END OF THE QUESTION PAPER**

**Q. 1 – Q. 25 carry one mark each.**

Q.1 The solution to the system of equations

$$\begin{bmatrix} 2 & 5 \\ -4 & 3 \end{bmatrix} \begin{Bmatrix} x \\ y \end{Bmatrix} = \begin{Bmatrix} 2 \\ -30 \end{Bmatrix}$$

is

- (A) 6, 2                      (B) -6, 2                      (C) -6, -2                      (D) 6, -2

Q.2 If  $f(t)$  is a function defined for all  $t \geq 0$ , its Laplace transform  $F(s)$  is defined as

- (A)  $\int_0^{\infty} e^{st} f(t) dt$                       (B)  $\int_0^{\infty} e^{-st} f(t) dt$   
 (C)  $\int_0^{\infty} e^{ist} f(t) dt$                       (D)  $\int_0^{\infty} e^{-ist} f(t) dt$

Q.3  $f(z) = u(x, y) + i v(x, y)$  is an analytic function of complex variable  $z = x + i y$  where  $i = \sqrt{-1}$ . If  $u(x, y) = 2xy$ , then  $v(x, y)$  may be expressed as

- (A)  $-x^2 + y^2 + \text{constant}$                       (B)  $x^2 - y^2 + \text{constant}$   
 (C)  $x^2 + y^2 + \text{constant}$                       (D)  $-(x^2 + y^2) + \text{constant}$

Q.4 Consider a Poisson distribution for the tossing of a biased coin. The mean for this distribution is  $\mu$ . The standard deviation for this distribution is given by

- (A)  $\sqrt{\mu}$                       (B)  $\mu^2$                       (C)  $\mu$                       (D)  $1/\mu$

Q.5 Solve the equation  $x = 10 \cos(x)$  using the Newton-Raphson method. The initial guess is  $x = \pi/4$ . The value of the predicted root after the first iteration, up to second decimal, is \_\_\_\_\_

Q.6 A rigid ball of weight 100 N is suspended with the help of a string. The ball is pulled by a horizontal force  $F$  such that the string makes an angle of  $30^\circ$  with the vertical. The magnitude of force  $F$  (in N) is \_\_\_\_\_

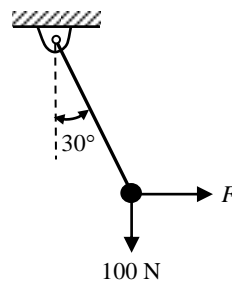

- Q.7 A point mass  $M$  is released from rest and slides down a spherical bowl (of radius  $R$ ) from a height  $H$  as shown in the figure below. The surface of the bowl is smooth (no friction). The velocity of the mass at the bottom of the bowl is

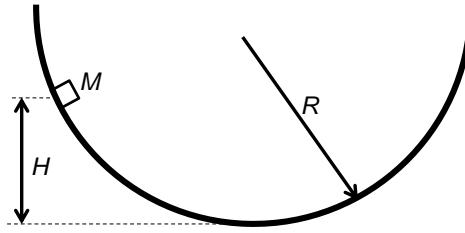

- (A)  $\sqrt{gH}$       (B)  $\sqrt{2gR}$       (C)  $\sqrt{2gH}$       (D) 0

- Q.8 The cross sections of two hollow bars made of the same material are concentric circles as shown in the figure. It is given that  $r_3 > r_1$  and  $r_4 > r_2$ , and that the areas of the cross-sections are the same.  $J_1$  and  $J_2$  are the torsional rigidities of the bars on the left and right, respectively. The ratio  $J_2/J_1$  is

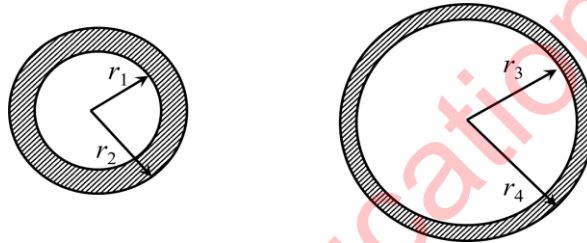

- (A)  $> 1$       (B)  $< 0.5$       (C)  $= 1$       (D) between 0.5 and 1

- Q.9 A cantilever beam having square cross-section of side  $a$  is subjected to an end load. If  $a$  is increased by 19%, the tip deflection decreases approximately by
- (A) 19%      (B) 29%      (C) 41%      (D) 50%

- Q.10 A car is moving on a curved horizontal road of radius 100 m with a speed of 20 m/s. The rotating masses of the engine have an angular speed of 100 rad/s in clockwise direction when viewed from the front of the car. The combined moment of inertia of the rotating masses is 10 kg-m<sup>2</sup>. The magnitude of the gyroscopic moment (in N-m) is \_\_\_\_\_

- Q.11 A single degree of freedom spring mass system with viscous damping has a spring constant of 10 kN/m. The system is excited by a sinusoidal force of amplitude 100 N. If the damping factor (ratio) is 0.25, the amplitude of steady state oscillation at resonance is \_\_\_\_\_ mm.

- Q.12 The spring constant of a helical compression spring DOES NOT depend on
- (A) coil diameter  
 (B) material strength  
 (C) number of active turns  
 (D) wire diameter

Q.13 The instantaneous stream-wise velocity of a turbulent flow is given as follows:

$$u(x, y, z, t) = \bar{u}(x, y, z) + u'(x, y, z, t)$$

The time-average of the fluctuating velocity  $u'(x, y, z, t)$  is

- (A)  $u'/2$                       (B)  $-\bar{u}/2$                       (C) zero                      (D)  $\bar{u}/2$

Q.14 For a floating body, buoyant force acts at the

- (A) centroid of the floating body  
(B) center of gravity of the body  
(C) centroid of the fluid vertically below the body  
(D) centroid of the displaced fluid

Q.15 A plastic sleeve of outer radius  $r_0 = 1$  mm covers a wire (radius  $r = 0.5$  mm) carrying electric current. Thermal conductivity of the plastic is  $0.15$  W/m-K. The heat transfer coefficient on the outer surface of the sleeve exposed to air is  $25$  W/m<sup>2</sup>-K. Due to the addition of the plastic cover, the heat transfer from the wire to the ambient will

- (A) increase  
(B) remain the same  
(C) decrease  
(D) be zero

Q.16 Which of the following statements are TRUE with respect to heat and work?

- (i) They are boundary phenomena  
(ii) They are exact differentials  
(iii) They are path functions

- (A) both (i) and (ii)      (B) both (i) and (iii)      (C) both (ii) and (iii)      (D) only (iii)

Q.17 Propane ( $C_3H_8$ ) is burned in an oxygen atmosphere with 10% deficit oxygen with respect to the stoichiometric requirement. Assuming no hydrocarbons in the products, the volume percentage of CO in the products is \_\_\_\_\_

Q.18 Consider two hydraulic turbines having identical specific speed and effective head at the inlet. If the speed ratio ( $N_1/N_2$ ) of the two turbines is 2, then the respective power ratio ( $P_1/P_2$ ) is \_\_\_\_\_

Q.19 The INCORRECT statement about regeneration in vapor power cycle is that

- (A) it increases the irreversibility by adding the liquid with higher energy content to the steam generator  
(B) heat is exchanged between the expanding fluid in the turbine and the compressed fluid before heat addition  
(C) the principle is similar to the principle of Stirling gas cycle  
(D) it is practically implemented by providing feed water heaters

- Q.20 The “Jominy test” is used to find  
 (A) Young’s modulus (B) hardenability  
 (C) yield strength (D) thermal conductivity
- Q.21 Under optimal conditions of the process the temperatures experienced by a copper work piece in fusion welding, brazing and soldering are such that  
 (A)  $T_{\text{welding}} > T_{\text{soldering}} > T_{\text{brazing}}$  (B)  $T_{\text{soldering}} > T_{\text{welding}} > T_{\text{brazing}}$   
 (C)  $T_{\text{brazing}} > T_{\text{welding}} > T_{\text{soldering}}$  (D)  $T_{\text{welding}} > T_{\text{brazing}} > T_{\text{soldering}}$
- Q.22 The part of a gating system which regulates the rate of pouring of molten metal is  
 (A) pouring basin (B) runner (C) choke (D) ingate
- Q.23 The non-traditional machining process that essentially requires vacuum is  
 (A) electron beam machining (B) electro chemical machining  
 (C) electro chemical discharge machining (D) electro discharge machining
- Q.24 In an orthogonal cutting process the tool used has rake angle of zero degree. The measured cutting force and thrust force are 500 N and 250 N, respectively. The coefficient of friction between the tool and the chip is \_\_\_\_\_

Q.25 Match the following:

P. Feeler gauge	I. Radius of an object
Q. Fillet gauge	II. Diameter within limits by comparison
R. Snap gauge	III. Clearance or gap between components
S. Cylindrical plug gauge	IV. Inside diameter of straight hole

- (A) P–III, Q–I, R–II, S–IV (B) P–III, Q–II, R–I, S–IV  
 (C) P–IV, Q–II, R–I, S–III (D) P–IV, Q–I, R–II, S–III

**Q. 26 – Q. 55 carry two marks each.**

- Q.26 Consider the function  $f(x) = 2x^3 - 3x^2$  in the domain  $[-1, 2]$ . The global minimum of  $f(x)$  is \_\_\_\_\_
- Q.27 If  $y = f(x)$  satisfies the boundary value problem  $y'' + 9y = 0$ ,  $y(0) = 0$ ,  $y(\pi/2) = \sqrt{2}$ , then  $y(\pi/4)$  is \_\_\_\_\_

Q.28 The value of the integral

$$\int_{-\infty}^{\infty} \frac{\sin x}{x^2 + 2x + 2} dx$$

evaluated using contour integration and the residue theorem is

- (A)  $-\pi \sin(1)/e$     (B)  $-\pi \cos(1)/e$     (C)  $\sin(1)/e$     (D)  $\cos(1)/e$

Q.29 Gauss-Seidel method is used to solve the following equations (as per the given order):

$$x_1 + 2x_2 + 3x_3 = 5$$

$$2x_1 + 3x_2 + x_3 = 1$$

$$3x_1 + 2x_2 + x_3 = 3$$

Assuming initial guess as  $x_1 = x_2 = x_3 = 0$ , the value of  $x_3$  after the first iteration is \_\_\_\_\_

Q.30 A block of mass  $m$  rests on an inclined plane and is attached by a string to the wall as shown in the figure. The coefficient of static friction between the plane and the block is 0.25. The string can withstand a maximum force of 20 N. The maximum value of the mass ( $m$ ) for which the string will not break and the block will be in static equilibrium is \_\_\_\_\_ kg.

Take  $\cos\theta = 0.8$  and  $\sin\theta = 0.6$ .

Acceleration due to gravity  $g = 10 \text{ m/s}^2$

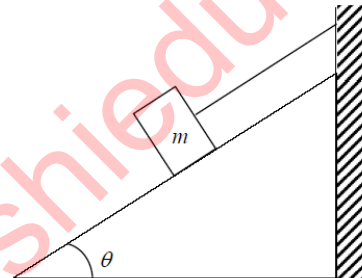

Q.31 A two-member truss  $PQR$  is supporting a load  $W$ . The axial forces in members  $PQ$  and  $QR$  are respectively

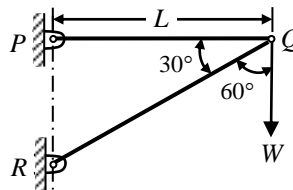

- (A)  $2W$  tensile and  $\sqrt{3}W$  compressive  
 (B)  $\sqrt{3}W$  tensile and  $2W$  compressive  
 (C)  $\sqrt{3}W$  compressive and  $2W$  tensile  
 (D)  $2W$  compressive and  $\sqrt{3}W$  tensile

- Q.32 A horizontal bar with a constant cross-section is subjected to loading as shown in the figure. The Young's moduli for the sections AB and BC are  $3E$  and  $E$ , respectively.

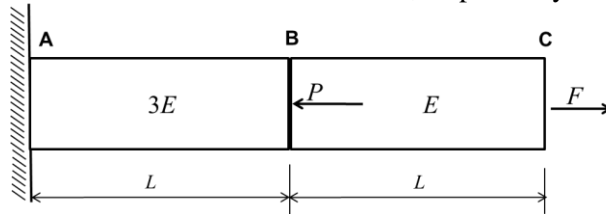

For the deflection at C to be zero, the ratio  $P/F$  is \_\_\_\_\_

- Q.33 The figure shows cross-section of a beam subjected to bending. The area moment of inertia (in  $\text{mm}^4$ ) of this cross-section about its base is \_\_\_\_\_

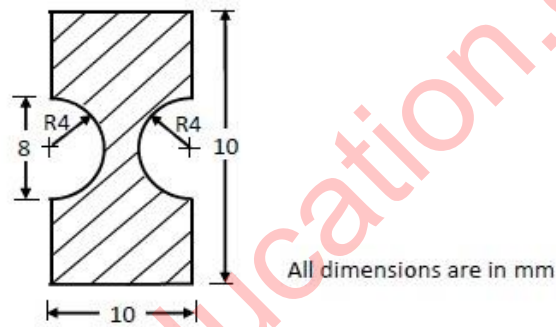

- Q.34 A simply-supported beam of length  $3L$  is subjected to the loading shown in the figure.

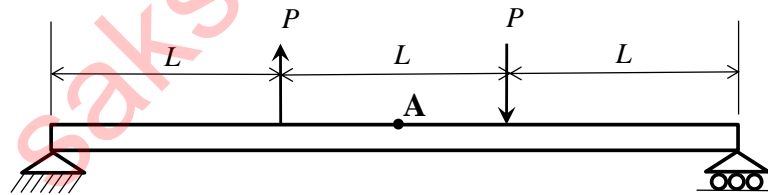

It is given that  $P = 1 \text{ N}$ ,  $L = 1 \text{ m}$  and Young's modulus  $E = 200 \text{ GPa}$ . The bending stress (in Pa) at the point A located at the top surface of the beam at a distance of  $1.5L$  from the left end is \_\_\_\_\_

(Indicate compressive stress by a negative sign and tensile stress by a positive sign.)



- Q.35 A slider crank mechanism with crank radius 200 mm and connecting rod length 800 mm is shown. The crank is rotating at 600 rpm in the counterclockwise direction. In the configuration shown, the crank makes an angle of  $90^\circ$  with the sliding direction of the slider, and a force of 5 kN is acting on the slider. Neglecting the inertia forces, the turning moment on the crank (in kN-m) is \_\_\_\_\_

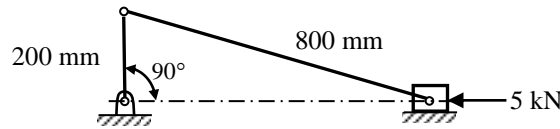

- Q.36 In the gear train shown, gear 3 is carried on arm 5. Gear 3 meshes with gear 2 and gear 4. The number of teeth on gear 2, 3, and 4 are 60, 20, and 100, respectively. If gear 2 is fixed and gear 4 rotates with an angular velocity of 100 rpm in the counterclockwise direction, the angular speed of arm 5 (in rpm) is

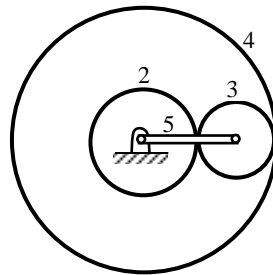

- (A) 166.7 counterclockwise (B) 166.7 clockwise  
(C) 62.5 counterclockwise (D) 62.5 clockwise

- Q.37 A solid disc with radius  $a$  is connected to a spring at a point  $d$  above the center of the disc. The other end of the spring is fixed to the vertical wall. The disc is free to roll without slipping on the ground. The mass of the disc is  $M$  and the spring constant is  $K$ . The polar moment of inertia for the disc about its centre is  $J = Ma^2/2$ .

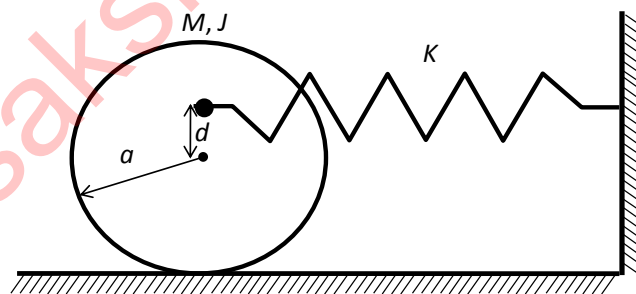

The natural frequency of this system in rad/s is given by

- (A)  $\sqrt{\frac{2K(a+d)^2}{3Ma^2}}$  (B)  $\sqrt{\frac{2K}{3M}}$  (C)  $\sqrt{\frac{2K(a+d)^2}{Ma^2}}$  (D)  $\sqrt{\frac{K(a+d)^2}{Ma^2}}$

- Q.38 The principal stresses at a point inside a solid object are  $\sigma_1 = 100$  MPa,  $\sigma_2 = 100$  MPa and  $\sigma_3 = 0$  MPa. The yield strength of the material is 200 MPa. The factor of safety calculated using Tresca (maximum shear stress) theory is  $n_T$  and the factor of safety calculated using von Mises (maximum distortional energy) theory is  $n_V$ . Which one of the following relations is TRUE?

- (A)  $n_T = (\sqrt{3}/2)n_V$   
(B)  $n_T = (\sqrt{3})n_V$   
(C)  $n_T = n_V$   
(D)  $n_V = (\sqrt{3})n_T$

Q.39

An inverted U-tube manometer is used to measure the pressure difference between two pipes A and B, as shown in the figure. Pipe A is carrying oil (specific gravity = 0.8) and pipe B is carrying water. The densities of air and water are  $1.16 \text{ kg/m}^3$  and  $1000 \text{ kg/m}^3$ , respectively. The pressure difference between pipes A and B is \_\_\_\_\_ kPa.

Acceleration due to gravity  $g = 10 \text{ m/s}^2$ .

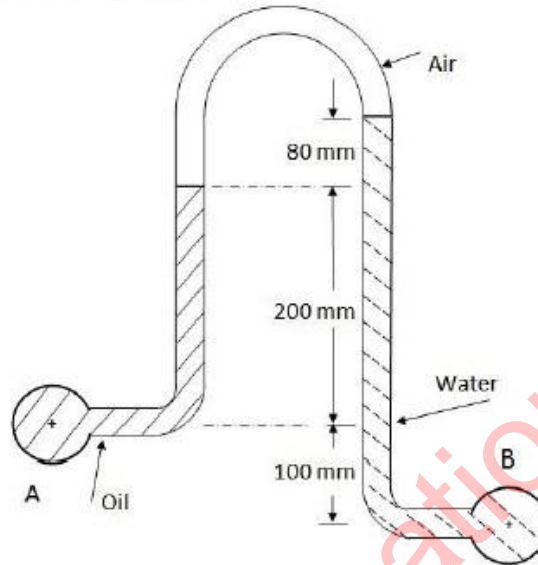

Q.40 Oil (kinematic viscosity,  $\nu_{oil} = 1.0 \times 10^{-5} \text{ m}^2/\text{s}$ ) flows through a pipe of 0.5 m diameter with a velocity of 10 m/s. Water (kinematic viscosity,  $\nu_w = 0.89 \times 10^{-6} \text{ m}^2/\text{s}$ ) is flowing through a model pipe of diameter 20 mm. For satisfying the dynamic similarity, the velocity of water (in m/s) is \_\_\_\_\_

Q.41 A steady laminar boundary layer is formed over a flat plate as shown in the figure. The free stream velocity of the fluid is  $U_o$ . The velocity profile at the inlet  $a-b$  is uniform, while that at a downstream location  $c-d$  is given by  $u = U_o \left[ 2 \left( \frac{y}{\delta} \right) - \left( \frac{y}{\delta} \right)^2 \right]$ .

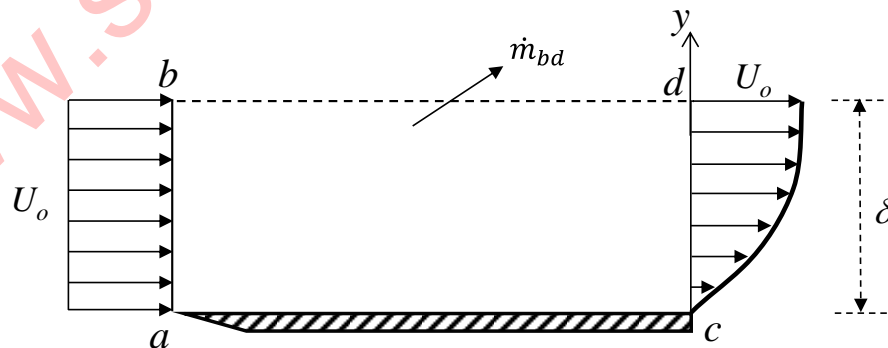

The ratio of the mass flow rate,  $\dot{m}_{bd}$ , leaving through the horizontal section  $b-d$  to that entering through the vertical section  $a-b$  is \_\_\_\_\_

Q.42 A steel ball of 10 mm diameter at 1000 K is required to be cooled to 350 K by immersing it in a water environment at 300 K. The convective heat transfer coefficient is  $1000 \text{ W/m}^2\text{-K}$ . Thermal conductivity of steel is  $40 \text{ W/m-K}$ . The time constant for the cooling process  $\tau$  is 16 s. The time required (in s) to reach the final temperature is \_\_\_\_\_

Q.43 An infinitely long furnace of  $0.5 \text{ m} \times 0.4 \text{ m}$  cross-section is shown in the figure below. Consider all surfaces of the furnace to be black. The top and bottom walls are maintained at temperature  $T_1 = T_3 = 927 \text{ }^\circ\text{C}$  while the side walls are at temperature  $T_2 = T_4 = 527 \text{ }^\circ\text{C}$ . The view factor,  $F_{1-2}$  is 0.26. The net radiation heat loss or gain on side 1 is \_\_\_\_\_  $\text{W/m}$ .

Stefan-Boltzmann constant =  $5.67 \times 10^{-8} \text{ W/m}^2\text{-K}^4$

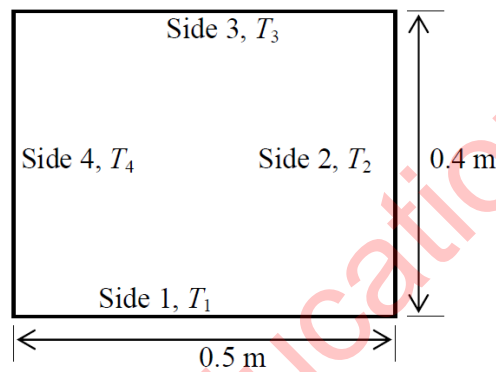

Q.44 A fluid (Prandtl number,  $Pr = 1$ ) at 500 K flows over a flat plate of 1.5 m length, maintained at 300 K. The velocity of the fluid is 10 m/s. Assuming kinematic viscosity,  $\nu = 30 \times 10^{-6} \text{ m}^2/\text{s}$ , the thermal boundary layer thickness (in mm) at 0.5 m from the leading edge is \_\_\_\_\_

Q.45 For water at  $25 \text{ }^\circ\text{C}$ ,  $dp_s/dT_s = 0.189 \text{ kPa/K}$  ( $p_s$  is the saturation pressure in kPa and  $T_s$  is the saturation temperature in K) and the specific volume of dry saturated vapour is  $43.38 \text{ m}^3/\text{kg}$ . Assume that the specific volume of liquid is negligible in comparison with that of vapour. Using the Clausius-Clapeyron equation, an estimate of the enthalpy of evaporation of water at  $25 \text{ }^\circ\text{C}$  (in kJ/kg) is \_\_\_\_\_

Q.46 An ideal gas undergoes a reversible process in which the pressure varies linearly with volume. The conditions at the start (subscript 1) and at the end (subscript 2) of the process with usual notation are:  $p_1 = 100 \text{ kPa}$ ,  $V_1 = 0.2 \text{ m}^3$  and  $p_2 = 200 \text{ kPa}$ ,  $V_2 = 0.1 \text{ m}^3$  and the gas constant,  $R = 0.275 \text{ kJ/kg-K}$ . The magnitude of the work required for the process (in kJ) is \_\_\_\_\_

- Q.47 In a steam power plant operating on an ideal Rankine cycle, superheated steam enters the turbine at 3 MPa and 350 °C. The condenser pressure is 75 kPa. The thermal efficiency of the cycle is \_\_\_\_\_ percent.

Given data:

For saturated liquid, at  $P = 75 \text{ kPa}$ ,  $h_f = 384.39 \text{ kJ/kg}$ ,  $v_f = 0.001037 \text{ m}^3/\text{kg}$ ,  $s_f = 1.213 \text{ kJ/kg-K}$

At 75 kPa,  $h_{fg} = 2278.6 \text{ kJ/kg}$ ,  $s_{fg} = 6.2434 \text{ kJ/kg-K}$

At  $P = 3 \text{ MPa}$  and  $T = 350 \text{ }^\circ\text{C}$  (superheated steam),  $h = 3115.3 \text{ kJ/kg}$ ,  $s = 6.7428 \text{ kJ/kg-K}$

- Q.48 A hypothetical engineering stress-strain curve shown in the figure has three straight lines PQ, QR, RS with coordinates P(0,0), Q(0.2,100), R(0.6,140) and S(0.8,130). 'Q' is the yield point, 'R' is the UTS point and 'S' the fracture point.

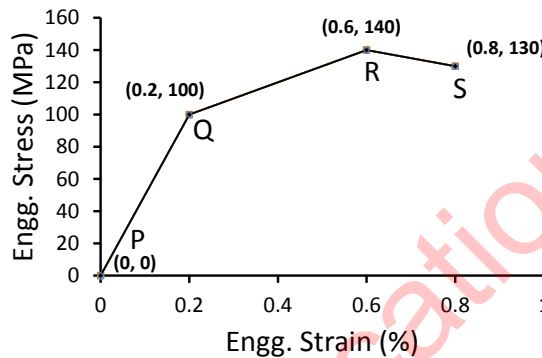

The toughness of the material (in  $\text{MJ/m}^3$ ) is \_\_\_\_\_

- Q.49 Heat is removed from a molten metal of mass 2 kg at a constant rate of 10 kW till it is completely solidified. The cooling curve is shown in the figure.

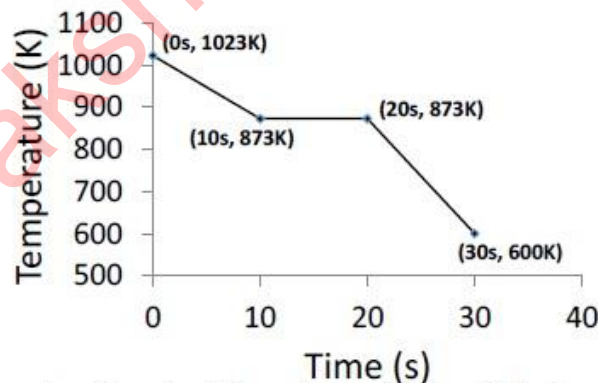

Assuming uniform temperature throughout the volume of the metal during solidification, the latent heat of fusion of the metal (in  $\text{kJ/kg}$ ) is \_\_\_\_\_

- Q.50 The tool life equation for HSS tool is  $VT^{0.14}f^{0.7}d^{0.4} = \text{Constant}$ . The tool life ( $T$ ) of 30 min is obtained using the following cutting conditions:

$V = 45 \text{ m/min}$ ,  $f = 0.35 \text{ mm}$ ,  $d = 2.0 \text{ mm}$

If speed ( $V$ ), feed ( $f$ ) and depth of cut ( $d$ ) are increased individually by 25%, the tool life (in min) is

- (A) 0.15                      (B) 1.06                      (C) 22.50                      (D) 30.0

- Q.51 A cylindrical job with diameter of 200 mm and height of 100 mm is to be cast using modulus method of riser design. Assume that the bottom surface of cylindrical riser does not contribute as cooling surface. If the diameter of the riser is equal to its height, then the height of the riser (in mm) is
- (A) 150                      (B) 200                      (C) 100                      (D) 125

- Q.52 A 300 mm thick slab is being cold rolled using roll of 600 mm diameter. If the coefficient of friction is 0.08, the maximum possible reduction (in mm) is \_\_\_\_\_

- Q.53 The figure below represents a triangle  $PQR$  with initial coordinates of the vertices as  $P(1,3)$ ,  $Q(4,5)$  and  $R(5,3.5)$ . The triangle is rotated in the  $X$ - $Y$  plane about the vertex  $P$  by angle  $\theta$  in clockwise direction. If  $\sin\theta = 0.6$  and  $\cos\theta = 0.8$ , the new coordinates of the vertex  $Q$  are

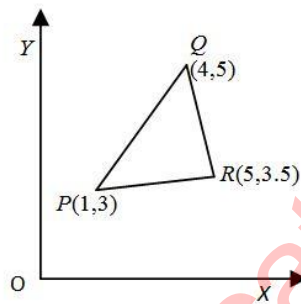

- (A) (4.6, 2.8)                      (B) (3.2, 4.6)                      (C) (7.9, 5.5)                      (D) (5.5, 7.9)

- Q.54 The annual demand for an item is 10,000 units. The unit cost is Rs. 100 and inventory carrying charges are 14.4% of the unit cost per annum. The cost of one procurement is Rs. 2000. The time between two consecutive orders to meet the above demand is \_\_\_\_\_ month(s).

- Q.55 Maximize  $Z = 15X_1 + 20X_2$   
subject to

$$12X_1 + 4X_2 \geq 36$$

$$12X_1 - 6X_2 \leq 24$$

$$X_1, X_2 \geq 0$$

The above linear programming problem has

- (A) infeasible solution                      (B) unbounded solution  
(C) alternative optimum solutions                      (D) degenerate solution

**END OF THE QUESTION PAPER**

Q. No	Type	Section	Key	Marks
1	MCQ	GA	A	1
2	MCQ	GA	B	1
3	MCQ	GA	A	1
4	MCQ	GA	A	1
5	MCQ	GA	C	1
6	MCQ	GA	C	2
7	MCQ	GA	B	2
8	MCQ	GA	D	2
9	MCQ	GA	C	2
10	MCQ	GA	C	2
1	MCQ	ME-1	D	1
2	MCQ	ME-1	B	1
3	MCQ	ME-1	A	1
4	MCQ	ME-1	A	1
5	NAT	ME-1	1.53 : 1.59	1
6	NAT	ME-1	55 : 60	1
7	MCQ	ME-1	C	1
8	MCQ	ME-1	A	1
9	MCQ	ME-1	D	1
10	NAT	ME-1	199 : 201	1
11	NAT	ME-1	19.9 : 20.1	1
12	MCQ	ME-1	B	1
13	MCQ	ME-1	C	1
14	MCQ	ME-1	D	1
15	MCQ	ME-1	A	1
16	MCQ	ME-1	B	1
17	NAT	ME-1	13.7 : 14.9	1
18	NAT	ME-1	0.24 : 0.26	1
19	MCQ	ME-1	A	1
20	MCQ	ME-1	B	1
21	MCQ	ME-1	D	1
22	MCQ	ME-1	C	1
23	MCQ	ME-1	A	1
24	NAT	ME-1	0.49 : 0.51	1
25	MCQ	ME-1	A	1
26	NAT	ME-1	-5.1 : -4.9	2
27	NAT	ME-1	-1.05 : -0.95	2
28	MCQ	ME-1	A	2
29	NAT	ME-1	-6 : -6	2
30	NAT	ME-1	4.95 : 5.05	2
31	MCQ	ME-1	B	2
32	NAT	ME-1	3.9 : 4.1	2
33	NAT	ME-1	1873 : 1879	2
34	NAT	ME-1	-1 : 1	2
35	NAT	ME-1	0.9 : 1.1	2
36	MCQ	ME-1	C	2
37	MCQ	ME-1	A	2
38	MCQ	ME-1	C	2
39	NAT	ME-1	-2.21 : -2.19 ; 2.19 : 2.21	2

40	NAT	ME-1	22.0 : 22.5	2
41	NAT	ME-1	0.32 : 0.34	2
42	NAT	ME-1	42.0 : 42.5	2
43	NAT	ME-1	24528 : 24532	2
44	NAT	ME-1	5.90 : 6.25	2
45	NAT	ME-1	2400 : 2500	2
46	NAT	ME-1	14.75 : 15.25	2
47	NAT	ME-1	25.8 : 26.1	2
48	NAT	ME-1	0.849 : 0.851	2
49	NAT	ME-1	49.9 : 50.1	2
50	MCQ	ME-1	B	2
51	MCQ	ME-1	A	2
52	NAT	ME-1	1.90 : 1.94	2
53	MCQ	ME-1	A	2
54	NAT	ME-1	1.9 : 2.1	2
55	MCQ	ME-1	B	2

[www.sakshieducation.com](http://www.sakshieducation.com)