





GATE 2014: General Instructions during Examination

1. Total duration of the GATE examination is **180** minutes.
2. The clock will be set at the server. The countdown timer at the top right corner of screen will display the remaining time available for you to complete the examination. When the timer reaches zero, the examination will end by itself. You need not terminate the examination or submit your paper.
3. Any useful data required for your paper can be viewed by clicking on the **Useful Common Data** button that appears on the screen.
4. Use the scribble pad provided to you for any rough work. Submit the scribble pad at the end of the examination.
5. You are allowed to use a non-programmable type calculator, however, sharing of calculators is not allowed.
6. The Question Palette displayed on the right side of screen will show the status of each question using one of the following symbols:

 You have not visited the question yet.

 You have not answered the question.

 You have answered the question.

 You have NOT answered the question, but have marked the question for review.

 You have answered the question, but marked it for review.

The **Marked for Review** status for a question simply indicates that you would like to look at that question again. *If a question is answered, but marked for review, then the answer will be considered for evaluation unless the status is modified by the candidate.*

Navigating to a Question :

7. To answer a question, do the following:
 - a. Click on the question number in the Question Palette to go to that question directly.
 - b. Select an answer for a multiple choice type question by clicking on the bubble placed before the 4 choices, namely A, B, C and D. Use the virtual numeric keypad to enter a number as answer for a numerical type question.
 - c. Click on **Save & Next** to save your answer for the current question and then go to the next question.
 - d. Click on **Mark for Review & Next** to save your answer for the current question and also mark it for review, and then go to the next question.

Caution: Note that your answer for the current question will not be saved, if you navigate to another question directly by clicking on a question number without saving the answer to the previous question.

You can view all the questions by clicking on the **Question Paper** button. This feature is provided, so that if you want you can just see the entire question paper at a glance.

Answering a Question :

8. Procedure for answering a multiple choice (MCQ) type question:
 - a. Choose one answer from the 4 options (A,B,C,D) given below the question, click on the bubble placed before the chosen option.
 - b. To deselect your chosen answer, click on the bubble of the chosen option again or click on the **Clear Response** button.
 - c. To change your chosen answer, click on the bubble of another option.
 - d. To save your answer, you MUST click on the **Save & Next** button.
9. Procedure for answering a numerical answer type question:
 - a. To enter a number as your answer, use the virtual numerical keypad.
 - b. A fraction (e.g. -0.3 or -.3) can be entered as an answer with or without '0' before the decimal point. As many as four decimal points, e.g. 12.5435 or 0.003 or -932.6711 or 12.82 can be entered.
 - c. To clear your answer, click on the **Clear Response** button.
 - d. To save your answer, you MUST click on the **Save & Next** button
10. To mark a question for review, click on the **Mark for Review & Next** button. *If an answer is selected (for MCQ) or entered (for numerical answer type) for a question that is **Marked for Review**, that answer will be considered in the evaluation unless the status is modified by the candidate.*
11. To change your answer to a question that has already been answered, first select that question for answering and then follow the procedure for answering that type of question.
12. Note that **ONLY** Questions for which answers are *saved* or *marked for review after answering* will be considered for evaluation.

Choosing a Section :

13. Sections in this question paper are displayed on the top bar of the screen. Questions in a Section can be viewed by clicking on the name of that Section. The Section you are currently viewing will be highlighted.
14. A checkbox is displayed for every optional Section, if any, in the Question Paper. To select the optional Section for answering, click on the checkbox for that Section.
15. If the checkbox for an optional Section is not selected, the **Save & Next** button and the **Mark for Review & Next** button will NOT be enabled for that Section. You will

only be able to see questions in this Section, but you will not be able to answer questions in the Section.

16. After clicking the **Save & Next** button for the last question in a Section, you will automatically be taken to the first question of the next Section in sequence.
17. You can move the mouse cursor over the name of a Section to view the answering status for that Section.

Changing the Optional Section :

18. After answering the chosen optional Section, partially or completely, you can change the optional Section by selecting the checkbox for a new Section that you want to attempt. A warning message will appear along with a table showing the number of questions answered in each of the previously chosen optional Sections and a checkbox against each of these Sections. Click on a checkbox against a Section that you want to reset and then click on the **RESET** button. Note that **RESETTING** a Section will **DELETE** all the answers for questions in that Section. Hence, if you think that you may want to select this Section again later, you will have to note down your answers for questions in that Section. If you do not want to reset the Section and want to continue answering the previously chosen optional Section, then click on the **BACK** button.
19. If you deselect the checkbox for an optional Section in the top bar, the following warning message will appear: "Deselecting the checkbox will **DELETE** all the answers for questions in this Section. Do you want to deselect this Section?" If you want to deselect, click on the **RESET** button. If you do not want to deselect, click on the **BACK** button.
20. You can shuffle between different Sections or change the optional Sections any number of times.

GATE 2014 Examination

XE: Engineering Sciences

Duration: 180 minutes

Maximum Marks: 100

Read the following instructions carefully.

1. To login, enter your Registration Number and password provided to you. Kindly go through the various symbols used in the test and understand their meaning before you start the examination.
2. Once you login and after the start of the examination, you can view all the questions in the question paper, by clicking on the **View All Questions** button in the screen.
3. This paper consists of 8 sections: **GA** (General Aptitude), **A** (Engineering Mathematics), **B** (Fluid Mechanics), **C** (Materials Science), **D** (Solid Mechanics), **E** (Thermodynamics), **F** (Polymer Science & Engineering) and **G** (Food Technology).
Section **GA** (General Aptitude) and Section **A** (Engineering Mathematics) are compulsory.
Attempt any **2 sections** out of the **6 optional Sections B through G**.
There are **10** questions carrying **15** marks in the compulsory General Aptitude (**GA**) section.
Question numbers 1 to 5 of this section carry 1 mark each, and question numbers 6 to 10 carry 2 marks each.
There are **11** questions carrying **15** marks in Section **A** (Engineering Mathematics).
Question numbers 1 to 7 of this section carry 1 mark each, and question numbers 8 to 11 carry 2 marks each.
Each of the other sections (Sections **B through G**) contains **22** questions carrying **35** marks.
In each of these sections, question numbers 1 to 9 carry 1 mark each and question numbers 10 to 22 carry 2 marks each.
4. Depending upon the GATE paper, there may be useful common data that may be required for answering the questions. If this paper has such useful data, the same can be viewed by clicking on the **Useful Common Data** button that appears at the top, right hand side of the screen.
5. The computer allotted to you at the examination center runs specialized software that permits only one answer to be selected for multiple-choice questions using a mouse and to enter a suitable number for the numerical answer type questions using the virtual keyboard and mouse.
6. Your answers shall be updated and saved on a server periodically and also at the end of the examination. The examination will **stop automatically** at the end of **180 minutes**.
7. In each paper a candidate can answer a total of 65 questions carrying 100 marks.
8. The question paper may consist of questions of **multiple choice type (MCQ)** and **numerical answer type**.
9. Multiple choice type questions will have four choices against A, B, C, D, out of which only **ONE** is the correct answer. The candidate has to choose the correct answer by clicking on the bubble (○) placed before the choice.
10. For numerical answer type questions, each question will have a numerical answer and there will not be any choices. **For these questions, the answer should be entered** by using the virtual keyboard that appears on the monitor and the mouse.
11. All questions that are not attempted will result in zero marks. However, wrong answers for multiple choice type questions (MCQ) will result in **NEGATIVE** marks. For all MCQ questions a wrong answer will result in deduction of $\frac{1}{3}$ marks for a 1-mark question and $\frac{2}{3}$ marks for a 2-mark question.
12. There is **NO NEGATIVE MARKING** for questions of **NUMERICAL ANSWER TYPE**.
13. Non-programmable type Calculator is allowed. Charts, graph sheets, and mathematical tables are **NOT** allowed in the Examination Hall. You must use the Scribble pad provided to you at the examination centre for all your rough work. The Scribble Pad has to be returned at the end of the examination.

Declaration by the candidate:

“I have read and understood all the above instructions. I have also read and understood clearly the instructions given on the admit card and shall follow the same. I also understand that in case I am found to violate any of these instructions, my candidature is liable to be cancelled. I also confirm that at the start of the examination all the computer hardware allotted to me is in proper working condition”.

Q. 1 – Q. 5 carry one mark each.

- Q.1 A student is required to demonstrate a high level of comprehension of the subject, especially in the social sciences.

The word closest in meaning to comprehension is

- (A) understanding (B) meaning (C) concentration (D) stability

- Q.2 Choose the most appropriate word from the options given below to complete the following sentence.

One of his biggest _____ was his ability to forgive.

- (A) vice (B) virtues (C) choices (D) strength

- Q.3 Rajan was not happy that Sajan decided to do the project on his own. On observing his unhappiness, Sajan explained to Rajan that he preferred to work independently.

Which one of the statements below is logically valid and can be inferred from the above sentences?

- (A) Rajan has decided to work only in a group.
 (B) Rajan and Sajan were formed into a group against their wishes.
 (C) Sajan had decided to give in to Rajan's request to work with him.
 (D) Rajan had believed that Sajan and he would be working together.

- Q.4 If $y = 5x^2 + 3$, then the tangent at $x = 0, y = 3$

- (A) passes through $x = 0, y = 0$ (B) has a slope of +1
 (C) is parallel to the x -axis (D) has a slope of -1

- Q.5 A foundry has a fixed daily cost of Rs 50,000 whenever it operates and a variable cost of Rs 800Q, where Q is the daily production in tonnes. What is the cost of production in Rs per tonne for a daily production of 100 tonnes?

Q. 6 – Q. 10 carry two marks each.

- Q.6 Find the odd one in the following group: ALRVX, EPVZB, ITZDF, OYEIK

- (A) ALRVX (B) EPVZB (C) ITZDF (D) OYEIK

- Q.7 Anuj, Bhola, Chandan, Dilip, Eswar and Faisal live on different floors in a six-storeyed building (the ground floor is numbered 1, the floor above it 2, and so on). Anuj lives on an even-numbered floor. Bhola does not live on an odd numbered floor. Chandan does not live on any of the floors below Faisal's floor. Dilip does not live on floor number 2. Eswar does not live on a floor immediately above or immediately below Bhola. Faisal lives three floors above Dilip. Which of the following floor-person combinations is correct?

	Anuj	Bhola	Chandan	Dilip	Eswar	Faisal
(A)	6	2	5	1	3	4
(B)	2	6	5	1	3	4
(C)	4	2	6	3	1	5
(D)	2	4	6	1	3	5

- Q.8 The smallest angle of a triangle is equal to two thirds of the smallest angle of a quadrilateral. The ratio between the angles of the quadrilateral is 3:4:5:6. The largest angle of the triangle is twice its smallest angle. What is the sum, in degrees, of the second largest angle of the triangle and the largest angle of the quadrilateral?
- Q.9 One percent of the people of country X are taller than 6 ft. Two percent of the people of country Y are taller than 6 ft. There are thrice as many people in country X as in country Y. Taking both countries together, what is the percentage of people taller than 6 ft?
- (A) 3.0 (B) 2.5 (C) 1.5 (D) 1.25
- Q.10 The monthly rainfall chart based on 50 years of rainfall in Agra is shown in the following figure. Which of the following are true? (k percentile is the value such that k percent of the data fall below that value)

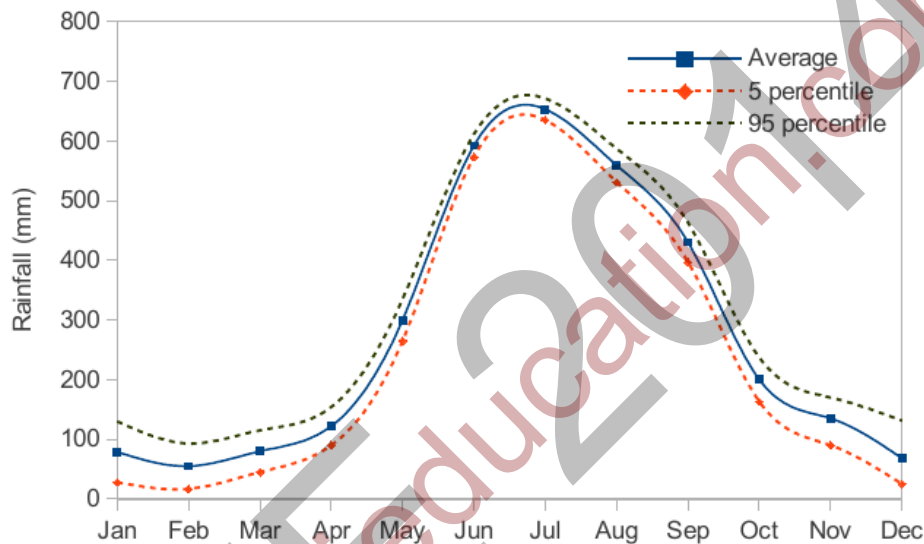

- (i) On average, it rains more in July than in December
 (ii) Every year, the amount of rainfall in August is more than that in January
 (iii) July rainfall can be estimated with better confidence than February rainfall
 (iv) In August, there is at least 500 mm of rainfall
- (A) (i) and (ii) (B) (i) and (iii)
 (C) (ii) and (iii) (D) (iii) and (iv)

END OF THE QUESTION PAPER

A : ENGINEERING MATHEMATICS (COMPULSORY)

Q. 1 – Q. 7 carry one mark each.

Q.1 If 1, 0, and -1 are the eigenvalues of a 3×3 matrix A, then the trace of $A^2 + 5A$ is equal to

_____.

Q.2 Which of the following is a solution of the differential equation $x^2 y'' + xy' + y = 4 \sin(\ln x)$, $x > 0$?

- (A) $y = 2x \sin(\ln x)$
- (B) $y = -2x \sin(\ln x)$
- (C) $y = -2 \ln x \cos(\ln x)$
- (D) $y = 2 \ln x \cos(\ln x)$

Q.3 At $z = 0$, the complex function $f(z) = z|z|^2$

- (A) satisfies the Cauchy-Riemann equations and is differentiable
- (B) satisfies the Cauchy-Riemann equations but is not differentiable.
- (C) does not satisfy the Cauchy-Riemann equations but is differentiable.
- (D) does not satisfy the Cauchy-Riemann equations and is not differentiable.

Q.4 Ten chocolates are distributed randomly among three children standing in a row. The probability that the first child receives exactly three chocolates is

- (A) $\frac{5 \times 2^{11}}{3^9}$
- (B) $\frac{5 \times 2^{10}}{3^9}$
- (C) $\frac{1}{3^9}$
- (D) $\frac{1}{3}$

Q.5 Let the function $f : [0, 5] \rightarrow R$ be defined by

$$f(x) = \begin{cases} 2x + 5, & 0 \leq x < 1 \\ 2x^2 + 5, & 1 \leq x < 2 \\ \frac{2}{3}x^3 + \frac{23}{3}, & 2 \leq x \leq 5. \end{cases}$$

The number of points where f is not differentiable in $(0, 5)$, is _____.

- Q.6 An integrating factor of the differential equation $(3x^2 y^3 e^y + y^3 + y^2) dx + (x^3 y^3 e^y - xy) dy = 0$ is
- (A) $\frac{1}{y}$
(B) $\frac{1}{y^2}$
(C) $\frac{1}{y^3}$
(D) $\ln y$
- Q.7 If a cubic polynomial passes through the points (0, 1), (1, 0), (2, 1) and (3, 10), then it also passes through the point
- (A) (-2, -11)
(B) (-1, -2)
(C) (-1, -4)
(D) (-2, -23)

Q. 8 – Q. 11 carry two marks each.

- Q.8 Let the function $f : [0, \infty) \rightarrow R$ be such that $f'(x) = \frac{8}{x^2 + 3x + 4}$ for $x > 0$ and $f(0) = 1$. Then $f(1)$ lies in the interval
- (A) [0, 1]
(B) [2, 3]
(C) [4, 5]
(D) [6, 7]
- Q.9 The perimeter of a rectangle having the largest area that can be inscribed in the ellipse $\frac{x^2}{8} + \frac{y^2}{32} = 1$, is _____.
- Q.10 If the work done in moving a particle once around a circle $x^2 + y^2 = 4$ under the force field $\vec{F}(x, y) = (2x - ay)\hat{i} + (2y + ax)\hat{j}$ is 16π , then $|a|$ is equal to _____.

Q.11

Let r and s be real numbers. If $A = \begin{pmatrix} 1 & 2 & 0 \\ 2 & 0 & 3 \\ r & s & 0 \end{pmatrix}$ and $b = \begin{pmatrix} 1 \\ 1 \\ s-1 \end{pmatrix}$, then the system of linear

equations $AX = b$ has

- (A) no solutions for $s \neq 2r$.
- (B) infinitely many solutions for $s = 2r \neq 2$.
- (C) a unique solution for $s = 2r = 2$.
- (D) infinitely many solutions for $s = 2r = 2$.

END OF THE QUESTION PAPER

B : FLUID MECHANICS

Q. 1 – Q. 9 carry one mark each.

- Q.1 A dam with a curved shape is shown in the figure. The cross sectional area of the dam (shaded portion) is 100 m^2 and its centroid is at $\bar{x} = 10 \text{ m}$. The vertical component of the hydrostatic force, F_z , is acting at a distance x_p . The value of x_p is ____ m.

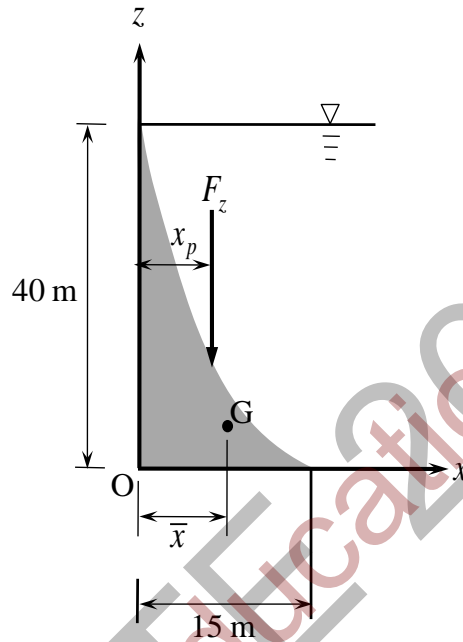

- Q.2 For an unsteady incompressible fluid flow, the velocity field is $\vec{V} = (3x^2 + 3)t \hat{i} - 6xyt \hat{j}$, where x , y are in meters and t is in seconds. Acceleration in m/s^2 at the point $x = 10 \text{ m}$ and $y = 0$, as measured by a stationary observer is
- (A) 303 (B) 162 (C) 43 (D) 13
- Q.3 For an incompressible flow, the existence of components of acceleration for different types of flow is described in the table below.

Type of Flow

- P: Steady and uniform
 Q: Steady and non-uniform
 R: Unsteady and uniform
 S: Unsteady and non-uniform

Components of Acceleration

- 1: Local exists, convective does not exist
 2: Both exist
 3: Both do not exist
 4: Local does not exist, convective exists

Which one of the following options connecting the left column with the right column is correct?

- (A) P – 1; Q – 4; R – 3; S – 2
 (B) P – 4; Q – 1; R – 2; S – 3
 (C) P – 3; Q – 2; R – 1; S – 4
 (D) P – 3; Q – 4; R – 1; S – 2

- Q.4 Velocity in a two-dimensional flow field is specified as: $u = x^2 y$; $v = -y^2 x$. The magnitude of the rate of angular deformation at a location ($x = 2$ m and $y = 1$ m) is ____ s^{-1} .
- Q.5 For a plane irrotational flow, equi-potential lines and streamlines are
- (A) parallel to each other. (B) at an angle of 90° to each other.
 (C) at an angle of 45° to each other. (D) at an angle of 60° to each other.
- Q.6 Flow around a Rankine half-body is represented by the superposition of
- (A) source and vortex flows. (B) source and uniform flows.
 (C) vortex and uniform flows. (D) source, vortex and uniform flows.
- Q.7 It is required to carry out model studies on a boat having a characteristic length of 3.6 m and travelling at a speed of 3 m/s. Assume the acceleration due to gravity as 10 m/s^2 and neglect the effects due to viscous and surface tension forces. The value of appropriate non-dimensional number is ____.
- Q.8 Which one of the following velocity profiles typically represents a fully developed incompressible, turbulent flow in a pipe?

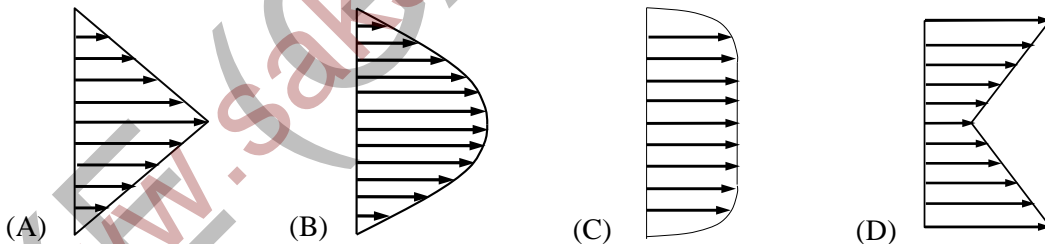

Q.9 Consider an incompressible, laminar flow past a circular cylinder of diameter d . The flow is uniform at the far upstream. Which one of the following figures typically represents the wake velocity profile just downstream of the cylinder?

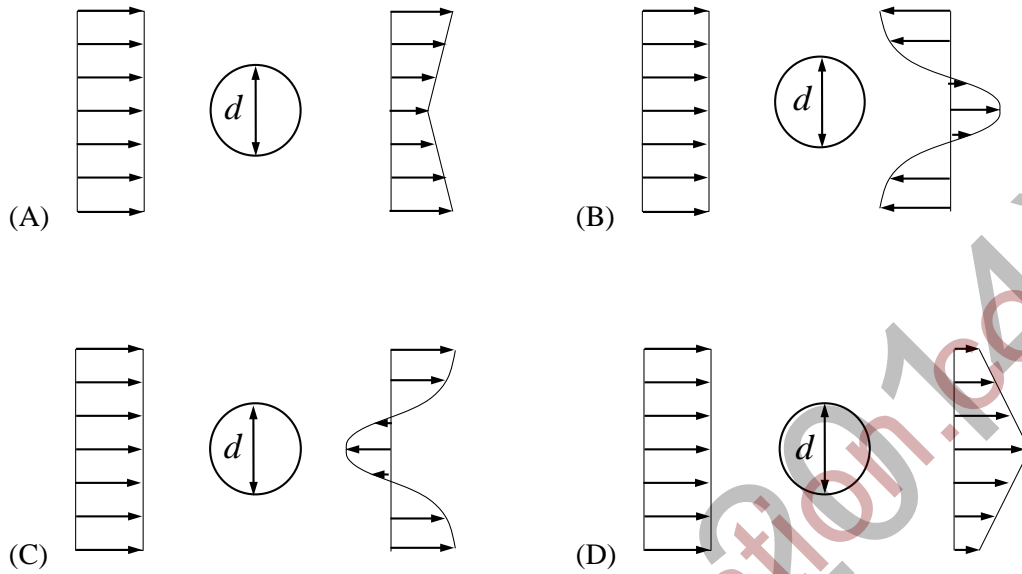

Q. 10 – Q. 22 carry two marks each.

- Q.10 A container of square cross-section is partially filled with a liquid of density ρ_1 . The cylinder is intended to float in another liquid of density ρ_2 as shown in the figure. The distance between metacentre and centre of buoyancy is $\frac{I}{V_{\text{sub}}}$, where I and V_{sub} are area moment of inertia of the cross-section and submerged volume, respectively. Neglect the weight of the container.

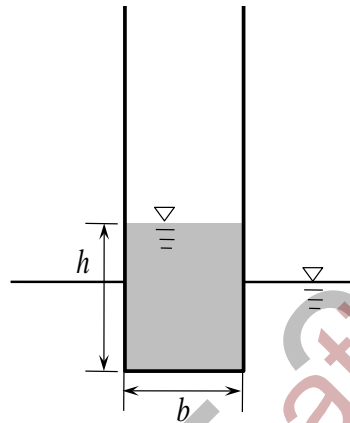

Which one of the following is the correct condition for stability?

- (A) $\frac{\rho_2}{6\rho_1} \frac{b}{h} - \frac{h}{b} \left(1 - \frac{\rho_1}{\rho_2}\right) > 0$ (B) $\frac{\rho_2}{6\rho_1} \frac{b}{h} - \frac{h}{b} \left(1 + \frac{\rho_1}{\rho_2}\right) > 0$
- (C) $\frac{\rho_2}{6\rho_1} \frac{b}{h} + \frac{h}{b} \left(1 - \frac{\rho_1}{\rho_2}\right) > 0$ (D) $\frac{\rho_2}{6\rho_1} \frac{b}{h} + \frac{h}{b} \left(1 + \frac{\rho_1}{\rho_2}\right) > 0$
- Q.11 In a steady state two-dimensional potential flow field due to a point source, the acceleration of a particle at a distance r from the point source is
- (A) proportional to r^{-1} . (B) proportional to r .
- (C) a constant. (D) proportional to r^{-3} .
- Q.12 Velocity in a two-dimensional flow at time t and location (x, y) is described as: $\vec{V} = 3t^2 \hat{i} + (x-1) \hat{j}$. The equation for the path line of a particle passing through the point $(1, 0)$ at $t = 0$ is

- (A) $x^4 - 4y^3 = 0$ (B) $(x-1)^3 - 2y^4 = 0$
- (C) $(x-1)^4 - 64y^3 = 0$ (D) $(x+1)^4 - 16y^3 = 0$

Q.13 The gravity driven flow over a hump of height h in a canal is shown in the figure. The height of the free surface from the canal bed at upstream of the hump is H . The free surface height reduces to H_1 above the hump.

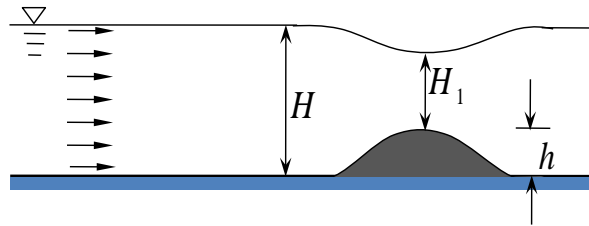

Assuming the canal bed to be horizontal, the discharge per unit width is given by

(A)

$$\sqrt{\frac{2g(H - H_1 - h)}{\frac{1}{H_1^2} - \frac{1}{H^2}}}$$

(B)

$$\sqrt{\frac{2gh}{\frac{1}{(H_1 + h)^2} - \frac{1}{H^2}}}$$

(C)

$$\sqrt{\frac{2g(H - H_1)}{\frac{1}{(H_1 + h)^2} - \frac{1}{H^2}}}$$

(D)

$$\sqrt{\frac{2g(H - H_1)}{\frac{1}{H_1^2} - \frac{1}{H^2}}}$$

Q.14 Steady state incompressible flow through a pipe network is shown in the figure. Inlets marked as (1), (2) and (3) and exit marked as (4), are shown with their respective diameters. The exit flow rate at (4) is $0.1 \text{ m}^3/\text{s}$. A 20% increase in flow rate through (3) results in a 10% increase in flow rate through (4). The original velocity through inlet (3) is _____ m/s.

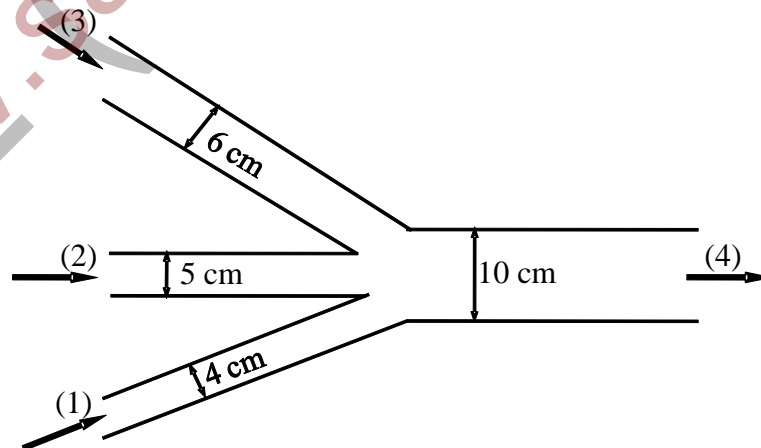

- Q.15 A reducing elbow is used to deflect water upward by 30° as shown in the figure. The mass flow rate at the inlet is 14 kg/s. Water is entering at a gauge pressure of 200 kPa and exits to the atmosphere. The cross-sectional area is 113 cm^2 at the inlet and 7 cm^2 at the exit. Density of water and acceleration due to gravity are 1000 kg/m^3 and 10 m/s^2 , respectively. Magnitude of x -component of the water force on the elbow is ____ N.

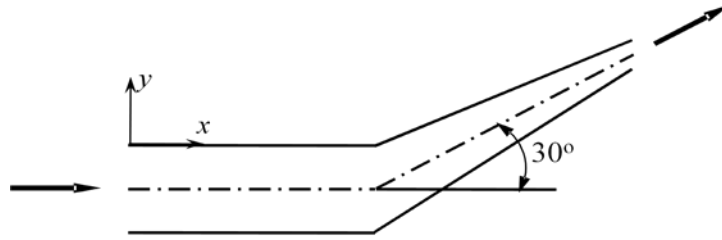

- Q.16 A source with a strength of k_1 and a vortex with a strength of k_2 are located at the origin. The resultant velocity at a radial distance r from the origin due to the superposition of the source and vortex is expressed as

(A) $\frac{k_1 + k_2}{r}$ (B) $\frac{\sqrt{k_1^2 + k_2^2}}{r}$ (C) $\frac{\sqrt{k_1^2 - k_2^2}}{r}$ (D) $\frac{k_1 - k_2}{r}$

- Q.17 Velocity potential for an incompressible fluid flow is given as: $\phi = 2(x^2 + 2y - y^2)$. Assume the value of stream function at the origin to be zero. The value of stream function at $[(x, y) \equiv (2, 2)]$ is ____.

- Q.18 The model of a conduit is scaled to 1/100 of the actual size. Seawater is used in the prototype and fresh water is used in the model. Velocity in the prototype is 0.5 m/s. Density and dynamic viscosity of the seawater are 1025 kg/m^3 and $1.07 \times 10^{-3} \text{ kg/m-s}$, respectively. Density and dynamic viscosity of fresh water are 1000 kg/m^3 and $1 \times 10^{-3} \text{ kg/m-s}$, respectively. Assume the viscous forces to be dominant. The velocity to be maintained in the model to ensure dynamic similarity is ____ m/s.

- Q.19 A fluid is flowing through a pipe of circular cross-section. Reynolds number of the flow is 1600. The head loss over a 45 m length of the pipe is 0.6 m. The average flow velocity of the fluid is 1 m/s and the acceleration due to gravity is 10 m/s^2 . The diameter of the pipe is ____ m.

Q.20 Consider a laminar flow over a flat plate of width w . At Section 1-1, the velocity profile is uniform as shown in the figure. The x -direction velocity profile at Section 2-2 is given by

$$\frac{u}{U} = 2\frac{y}{\delta} - \left(\frac{y}{\delta}\right)^2, \text{ where } \delta \text{ is the boundary layer thickness.}$$

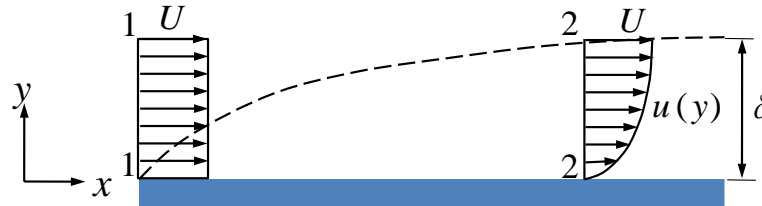

The volume flow rate through Section 2-2 is given by

- (A) $\frac{1}{2}U w \delta$ (B) $\frac{1}{3}U w \delta$ (C) $U w \delta$ (D) $\frac{2}{3}U w \delta$

Q.21 A cube of weight W and side a falls at a constant speed in a medium as shown in the figure. If the medium is air (mass density $=\rho_{\text{air}}$) let U_{air} be the velocity of the cube. If the medium is water (mass density $=\rho_{\text{water}}$) let U_{water} be the velocity of the cube.

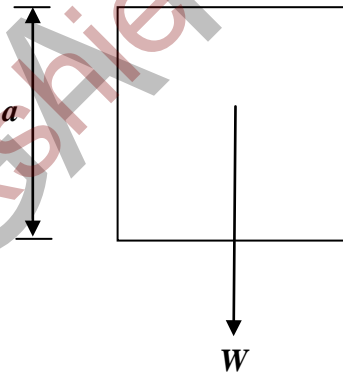

Neglecting the buoyancy force and assuming drag coefficient to be same for both cases, the ratio of

velocities, $\left(\frac{U_{\text{air}}}{U_{\text{water}}}\right)$ is given by

- (A) $\frac{\rho_{\text{air}}}{\rho_{\text{water}}}$ (B) $\sqrt{\frac{\rho_{\text{air}}}{\rho_{\text{water}}}}$ (C) $\sqrt{\frac{\rho_{\text{water}}}{\rho_{\text{air}}}}$ (D) 1

- Q.22 Water is flowing through a venturimeter having a diameter of 0.25 m at the entrance (Station 1) and 0.125 m at the throat (Station 2) as shown in the figure. A mercury manometer measures the piezometric head difference between Stations 1 and 2 as 1.3505 m. The loss of head between these two stations, is $1/7$ times the velocity head at the Station 2. Assume the acceleration due to gravity to be 10 m/s^2 . The velocity of water at the throat is ____ m/s.

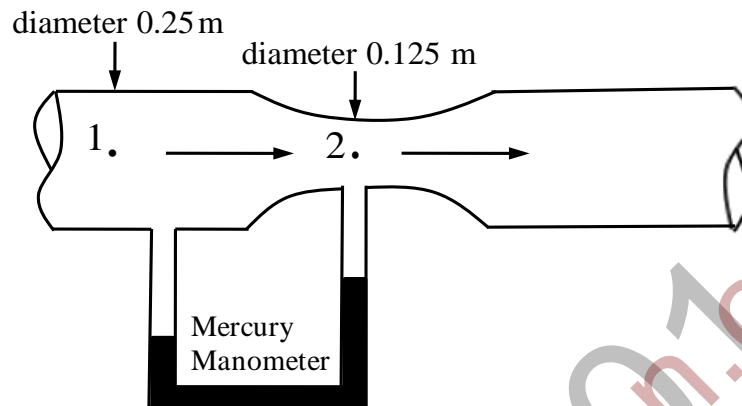

END OF THE QUESTION PAPER

C : MATERIALS SCIENCE

Useful constants

Avogadro's Number	: $6.023 \times 10^{23} \text{ mol}^{-1}$
Boltzmann's constant, k	: $1.38 \times 10^{-23} \text{ J.K}^{-1}$
Electron Charge, e	: $1.6 \times 10^{-19} \text{ C}$
Electron rest mass, m_0	: $9.1 \times 10^{-31} \text{ kg}$
Universal gas constant, R	: $8.314 \text{ J.mol}^{-1}.\text{K}^{-1}$
Speed of light, c	: $3 \times 10^8 \text{ m.s}^{-1}$
Planck's constant, h	: $6.63 \times 10^{-34} \text{ J.s}$
1 eV = $1.6 \times 10^{-19} \text{ J}$	

Q. 1 – Q. 9 carry one mark each.

- Q.1 Neoprene is rendered non-inflammable because
 (A) it has a highly cross-linked structure
 (B) it has a highly linear chain structure
 (C) of the presence of chlorine atom in the structure
 (D) of the absence of chlorine atom in the structure
- Q.2 Nylon-6 is manufactured from
 (A) caprolactum
 (B) adipic acid and hexamethylene diamine
 (C) maleic anhydride and hexamethylene diamine
 (D) sebasic acid and hexamethylene diamine
- Q.3 At room temperature, the typical barrier potential for silicon p-n junction in Volt (V) is
 (A) 0.7×10^{-23} (B) 0.07 (C) 0.70 (D) 7.0
- Q.4 Quantitative measurement of the roughness of a polysilicon wafer can be performed with
 (A) scanning tunneling microscopy (B) scanning electron microscopy
 (C) transmission electron microscopy (D) atomic force microscopy
- Q.5 The temperature of the antiferromagnetic-to-paramagnetic transition is called
 (A) Curie temperature (B) Curie-Weiss temperature
 (C) Neel temperature (D) Debye temperature
- Q.6 At low injection level, a forward biased p-n junction would have
 (A) no charge carriers
 (B) minority carrier concentration much more than majority carrier concentration
 (C) minority carrier concentration equal to majority carrier concentration
 (D) minority carrier concentration much less than majority carrier concentration
- Q.7 Which of the following mechanical properties of a material depend on the mobile dislocation density in it.
 (P) Young's modulus (Q) yield strength (R) ductility (S) fracture toughness
 (A) P, Q, R (B) Q, R, S (C) P, R, S (D) S, P, Q
- Q.8 The equilibrium concentration of vacancies in a pure metal
 (A) increases exponentially with temperature (B) decreases exponentially with temperature
 (C) varies linearly with temperature (D) is independent of temperature

- Q.9 The materials belonging to which one of the following crystal classes would be both piezoelectric and ferroelectric
- (A) 222 (B) 4mm (C) $\bar{1}$ (D) 2/m

Q. 10 – Q. 22 carry two marks each.

- Q.10 Polymerized isotactic polybutadiene has a molecular weight of 3×10^5 g/mol. The degree of polymerization is _____.
- Q.11 A bar of Ti with Young's modulus of 110 GPa and yield strength of 880 MPa is tested in tension. It is noticed that the alloy does not exhibit any strain hardening and fails at a total strain of 0.108. The mechanical energy that is necessary to break the material in MJ/m³ is _____.
- Q.12 A copper cup weighing 140 g contains 80 g of water at 4 °C. Specific heats of water and copper are 4.18 and 0.385 J/g °C, respectively. If 100 g of water that is at 90 °C is added to the cup, the final temperature of water in °C is _____.

- Q.13 Match the reaction in **Column I** with its name in **Column II**.

L – liquid, α , β , γ – different solid solution phases

Column I

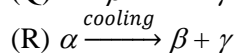
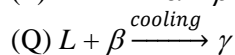
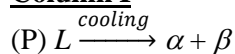

(A) P-1, Q-4, R-3

(C) P-2, Q-3, R-1

Column II

(1) peritectic

(2) eutectic

(3) monotectic

(4) eutectoid

(B) P-2, Q-1, R-4

(D) P-4, Q-2, R-3

- Q.14 The Young's modulus of a unidirectional SiC fiber reinforced Ti matrix composite is 185 GPa. If the Young's moduli of Ti and SiC are 110 and 360 GPa respectively, the volume fraction of fibers in the composite is _____.

- Q.15 Match the composite in **Column I** with the most suitable application in **Column II**.

Column I

- (P) Glass fibre reinforced plastic
 (Q) SiC particle reinforced Al alloy
 (R) Carbon-carbon composite
 (S) Metal fibre reinforced rubber

(A) P-4, Q-5, R-1, S-2

(C) P-5, Q-4, R-1, S-3

Column II

- (1) Missile cone heads
 (2) Commercial automobile chassis
 (3) Airplane wheel tyres
 (4) Car piston rings
 (5) High performance skate boards

(B) P-3, Q-5, R-2, S-4

(D) P-4, Q-2, R-3, S-1

Q.16 Which among the following rules need to be satisfied for obtaining an isomorphous phase diagram in a binary alloy system?

- (P) The atomic size difference should be less than 15%.
 (Q) Both the end components should have the same crystal structure
 (R) The valency of the end components should be the same.
 (S) The end components should have dissimilar electronegativities

(A) P, Q, R (B) Q, R, S (C) R, S, P (D) S, P, Q

Q.17 The energy in eV and the wavelength in μm , respectively, of the photon emitted when an electron in a hydrogen atom falls from $n = 4$ to $n = 2$ state is

(A) 3.0, 0.413 (B) 2.55, 0.365 (C) 2.75, 0.451 (D) 2.55, 0.487

Q.18 The weight in kg of gallium (Ga) to be mixed with arsenic (As) for obtaining 1.0 kg of gallium arsenide (GaAs) is _____.

($M_{\text{Ga}} = 69.72 \text{ g/mol}$; $M_{\text{As}} = 74.92 \text{ g/mol}$)

Q.19 Match the material in **Column I** with the property in **Column II**

Column I

- (P) $\text{Pb}(\text{Zr}, \text{Ti})\text{O}_3$
 (Q) $\text{Ni}_{50}\text{Ti}_{50}$
 (R) GaAs
 (S) $\text{YBa}_2\text{Cu}_3\text{O}_7$

(A) P-1, Q-2, R-3, S-4
 (C) P-4, Q-1, R-2, S-3

Column II

- (1) Shape memory alloy
 (2) Piezoelectric ceramic
 (3) High temperature superconductor
 (4) Optoelectronic semiconductor

(B) P-2, Q-3, R-4, S-1
 (D) P-2, Q-1, R-4, S-3

Q.20 Relevant portion of a binary phase diagram of elements A and B is shown below. The mass fraction of liquid phase at 1000°C for an alloy with 15 wt.% B is _____.

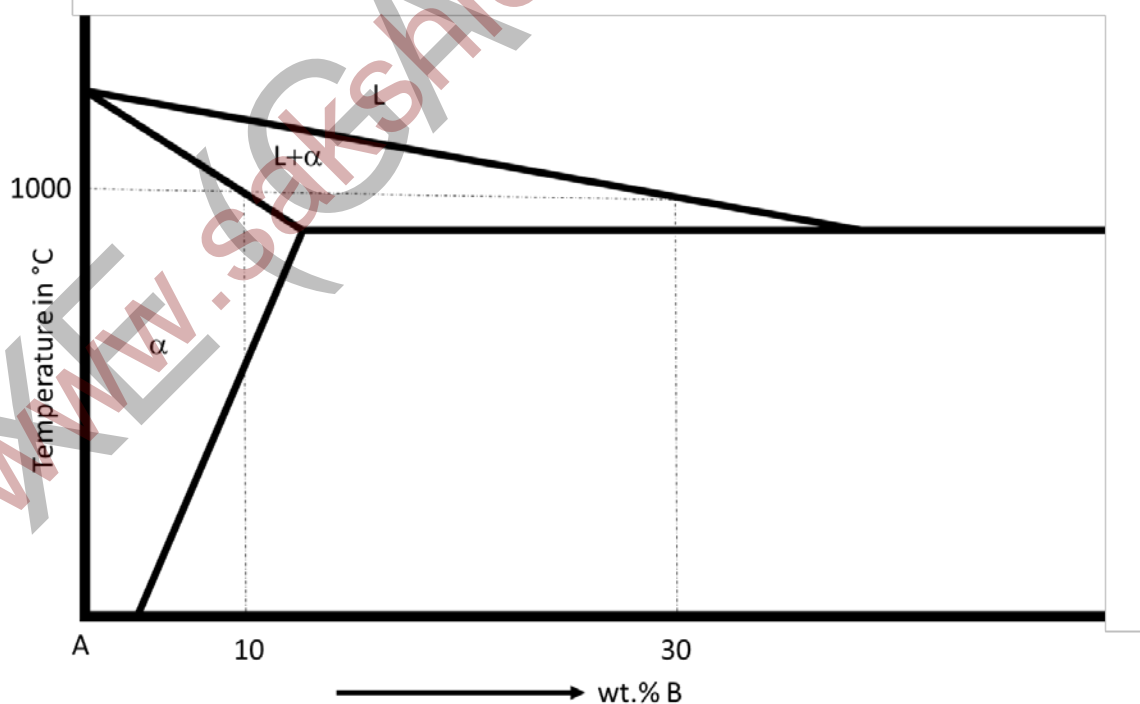

Q.21 The expected diffraction angle (in degrees) for the first order reflection from the (113) set of planes for face centered cubic Pt (lattice parameter = 0.392 nm) using monochromatic radiation of wavelength 0.1542 nm is _____.

- Q.22 The diffusion coefficients of Mg in Al at 500 and 550 °C are 1.9×10^{-13} and 5.8×10^{-13} m²/s respectively. The activation energy for diffusion of Mg in Al in kJ/mol is _____.

END OF THE QUESTION PAPER

XE (GATE 2014)
www.sakshieducation.com

D: SOLID MECHANICS

Q. 1 – Q. 9 carry one mark each.

- Q.1 A steel wire of diameter 5 mm is bent around a cylindrical drum of radius 0.5 m. The steel wire has modulus of elasticity of 200 GPa. Find the bending moment in the wire in N-m.

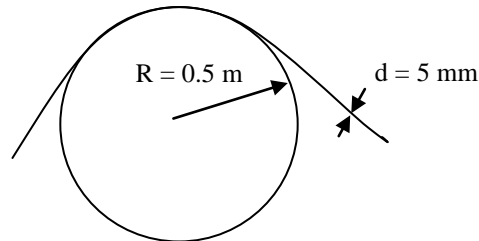

- Q.2 A compressed air tank having an inner diameter of 480 mm and a wall thickness of 8 mm is formed by welding two steel hemispheres. If the allowable shear stress in the steel is 40 MPa, find the maximum permissible pressure (in MPa) inside the tank.
- Q.3 The Euler's buckling load of a column fixed at both the ends is P . If one of the ends is made free, the buckling load shall change to
- (A) $P/16$ (B) $P/8$
(C) $P/4$ (D) $P/2$
- Q.4 A point in a body is subjected to a bi-axial state of stress, equal in magnitude but opposite in nature. On a plane inclined at an angle 45° with respect to x -axis (passing through the point), the
- (A) shear and normal stresses are zero
(B) normal stress is maximum and shear stress is zero
(C) shear stress is maximum and normal stress is zero
(D) shear stress is maximum and normal stress is non-zero

Q.5 A weightless beam subjected to two point loads is shown in the figure below.

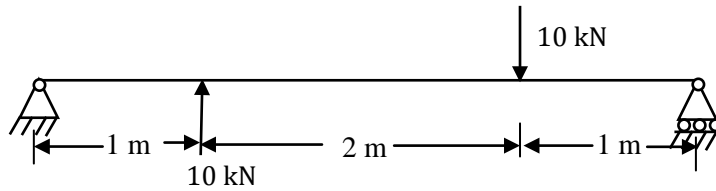

The shear force diagram of the beam is

- (A)
- (B)
- (C)
- (D)

Q.6 For the pin jointed truss, find the axial force (in kN) in the member 2-5.

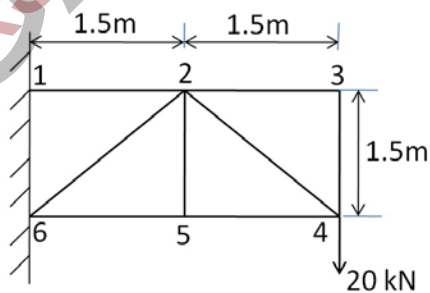

- Q.7 The supporting structure of a water tank is made of reinforced concrete (RC) with a tubular cross section of inner diameter d_i , outer diameter d_o , height l , and Young's modulus E . The mass of the tank is m . If mass of the supporting structure is neglected, then the natural frequency of the water tank in transverse direction is

(A) $\sqrt{\frac{3\pi E(d_o^4 - d_i^4)}{64l^3m}}$ (B) $\sqrt{\frac{\pi E(d_o^4 - d_i^4)}{8l^3m}}$

(C) $\sqrt{\frac{384\pi E(d_o^4 - d_i^4)}{360l^3m}}$ (D) $\sqrt{\frac{\pi E(d_o^4 - d_i^4)}{64l^3m}}$

- Q.8 A mass is attached to a spring and placed horizontally in a frictionless surface. A simple pendulum has been pivoted to the mass. The degree of freedom of this system is

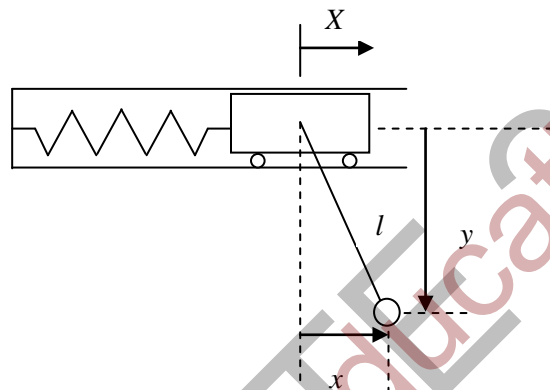

- (A) 1 (B) 2 (C) 3 (D) 4

Q.9 Consider the following two statements

Statement 1: A body of weight W falls from a height h and strikes the ground. If the body starts from rest, the velocity with which it strikes the ground is $\sqrt{2gh}$, where g is the acceleration due to gravity.

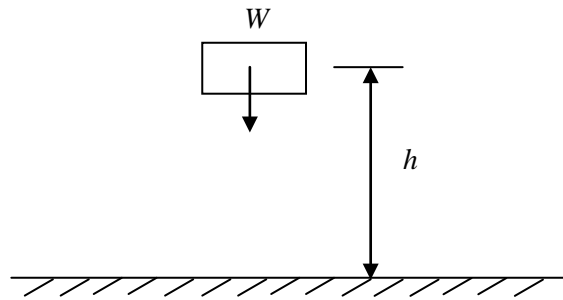

Statement 2: If the same body (initially at rest) slides without friction along an inclined plane PQ (angle of inclination α) starting from an elevation h above point Q , then its velocity at point Q is $\sqrt{2gh}$

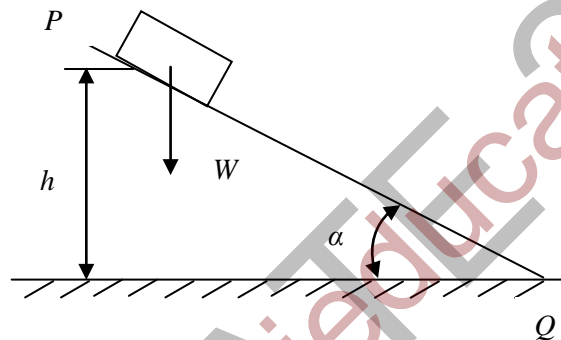

The correct option is

- (A) Both statements 1 and 2 are true
- (B) Statement 1 is true and 2 is false
- (C) Statement 1 is false and 2 is true
- (D) Both statements 1 and 2 are false

Q. 10 – Q. 22 carry two marks each.

Q.10 A composite bar of length ‘L’ is made of a centrally placed steel plate (50 mm wide x 10 mm thick) with two copper plates (each 30 mm wide x 5 mm thick) connected rigidly on each side. If the temperature of the composite bar is raised by 50°C, find the stress developed in each copper plate in MPa.

(For Steel: $E_s = 2 \times 10^5$ MPa and $\alpha_s = 12 \times 10^{-6} / ^\circ\text{C}$; For Copper: $E_c = 1 \times 10^5$ MPa and $\alpha_c = 17 \times 10^{-6} / ^\circ\text{C}$)

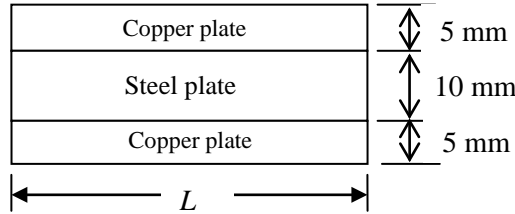

Q.11 The vertical deflection at the free end of the cantilever beam as shown in figure is

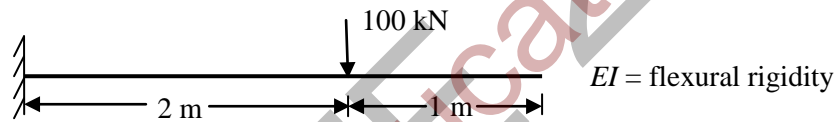

- (A) $1400/EI$ (B) $1400/3EI$ (C) $200/EI$ (D) $100/EI$

Q.12 A hollow shaft and a solid shaft have the same length and the same outer radius R . The inner radius of the hollow shaft is $0.6 R$. Assuming that both the shafts are made of same material and are subjected to the same torque, find the ratio of shear stress in hollow shaft to that in solid shaft.

Q.13 A beam with overhangs carries one point load acting downwards and the other upward. The clockwise moment Pb is applied at each support. The bending moment at the midpoint of the beam is

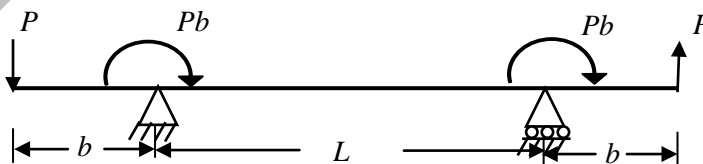

- (A) 0 (B) $PL/2$ (C) PL (D) PbL

Q.14 A cantilever beam of length L supports a concentrated load P at the free end. The cross section of the beam is rectangular with constant width b and varying depth h . The depth h of this idealized cantilever beam varies in such a way that the maximum normal stress at every cross section remains equal to the allowable bending stress. Considering only the bending stresses, the depth h_x of the fully stressed beam at any distance x from the free end shall vary

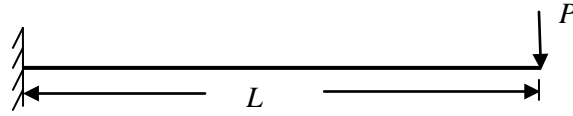

- (A) with square of x
- (B) with square root of x
- (C) linearly with x
- (D) with cube of x

Q.15 A cantilever beam is subjected to following three different loading conditions:
 (a) a concentrated load P at its free end,
 (b) a couple M_o at its free end and
 (c) both loads acting simultaneously

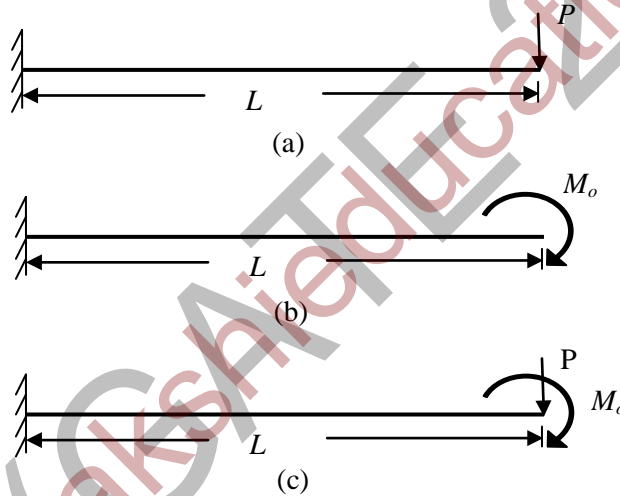

The flexural rigidity of the beam may be assumed as EI . The strain energy due to bending when both loads act simultaneously

(A) can be determined by applying the principle of superposition and the strain energy is

$$\frac{P^2 L^3}{6EI} + \frac{M_o^2 L}{2EI}$$

(B) can be determined by applying the principle of superposition and the strain energy is

$$\frac{P^2 L^2}{6EI} + \frac{M_o L^3}{2EI}$$

(C) cannot be determined by applying the principle of superposition and the strain energy is

$$\frac{P^2 L^3}{6EI} + \frac{M_o^2 L}{2EI} + \frac{PM_o L^2}{2EI}$$

(D) cannot be determined by applying the principle of superposition and the strain energy is

$$\frac{P^2 L^2}{6EI} + \frac{M_o L^3}{2EI} + \frac{PM_o L^2}{2EI}$$

Q.16 A tapered rod has diameter d_1 at one end which reduces uniformly to a diameter d_2 over the length (L). If the modulus of elasticity of the material is E , the change in the length of the rod due to the application of axial force (P) is

- (A) $\frac{4PL}{\pi E d_1 d_2}$ (B) $\frac{4PL}{\pi E (d_1^2 - d_2^2)}$ (C) $\frac{PL}{\pi E d_1 d_2}$ (D) $\frac{2PL}{\pi E (d_1^2 - d_2^2)}$

Q.17 For a point in a body subjected to a plane stress condition ($\sigma_x = 100$ MPa, $\sigma_y = 50$ MPa and $\tau_{xy} = \tau_{yx} = 25$ MPa), the maximum principal stress in MPa is _____

Q.18 An isotropic body is subjected to a state of stress given by: $\sigma_x = 10$ MPa and $\tau_{xy} = \tau_{yx} = -20$ MPa. Assuming $G = 0.4E$, the volumetric strain is

- (A) $5/E$ (B) $7.5/E$ (C) $10/E$ (D) $15/E$

Q.19 A block of weight Q rests on an inclined plane and it is attached to a string which runs over a frictionless pulley to carry a block of weight P at its other end. The coefficient of friction between the block of weight Q and the inclined plane is μ . Consider the following cases:

Case I: weight Q starts moving down the inclined plane

Case II: weight P starts falling down

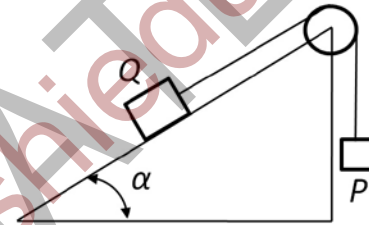

The limiting values of ratio P/Q for Case I and Case II respectively are

- (A) $(\sin \alpha - \mu \cos \alpha)$ and $(\sin \alpha + \mu \cos \alpha)$
 (B) $(\mu \sin \alpha - \cos \alpha)$ and $(\mu \sin \alpha + \cos \alpha)$
 (C) $(\sin \alpha + \mu \cos \alpha)$ and $(\sin \alpha - \mu \cos \alpha)$
 (D) $(\mu \sin \alpha + \cos \alpha)$ and $\mu(\sin \alpha - \cos \alpha)$

- Q.20 To unload an item from a truck a crane boom is raised with a constant angular velocity of 1 rad/s relative to the cab and then the cab is rotated about a vertical axis with constant angular velocity of 0.5 rad/s.

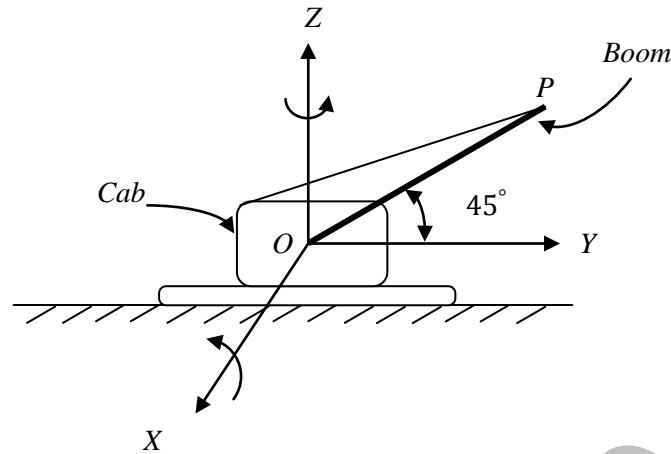

If the length of the boom (OP) is 10 m, the velocity of the tip (P) of the boom in m/s is

- (A) $\frac{\sqrt{2}}{5}(-2\hat{i} - \hat{j} + 2\hat{k})$ (B) $\frac{\sqrt{2}}{5}(-\hat{i} - 2\hat{j} + \hat{k})$
 (C) $\frac{5}{\sqrt{2}}(-2\hat{i} - \hat{j} + 2\hat{k})$ (D) $\frac{5}{\sqrt{2}}(-\hat{i} - 2\hat{j} + 2\hat{k})$
- Q.21 A block of mass 5 kg moves up on a smooth inclined plane with a velocity of 10 m/s in the direction shown. A bullet of mass 60 g travelling at 500 m/s strikes the block centrally and gets embedded in it. The velocity of the block and embedded bullet in m/s immediately after the impact is

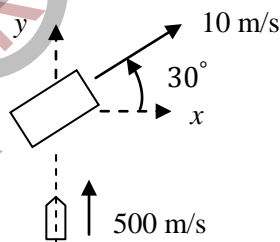

- (A) 12.54 at 30° (B) 13.84 at 51.78° (C) 13.84 at 30° (D) 15.62 at 51.78°

- Q.22 A balloon with ballast (weight) inside it has a gross weight of 500 N. It is falling vertically with a constant acceleration of 2 m/s^2 . If air resistance is negligible, find the weight of ballast (in N) that must be thrown out in order to give the balloon an upward acceleration of 2 m/s^2 . (Acceleration due to gravity, $g = 9.81 \text{ m/s}^2$)

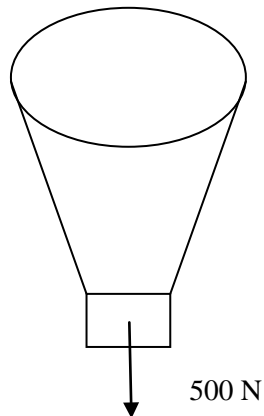

END OF THE QUESTION PAPER

E : THERMODYNAMICS**Notations used:**

P -pressure, V -volume, T -temperature, S -entropy, H -enthalpy, U -internal energy, c_p -specific heat at constant pressure, c_v -specific heat at constant volume; specific properties are designated by lower case symbols.

Subscripts: R -reduced, C -critical, f -saturated liquid, g -saturated vapor,

Properties of air: $c_p = 1.005$ kJ/(kg.K), specific heat ratio $\gamma = 1.4$, Gas constant = 0.287 kJ/(kg.K), Molecular weight = 29 gm/mol.

Universal gas constant = 8.314 kJ/(kmol.K).

Q. 1 – Q. 9 carry one mark each.

Q.1 Entropy is a

- (A) Path function (B) Point function
(C) Property independent function (D) Neither path nor point function

Q.2 A small container has gas at high pressure. It is placed in an evacuated space. If the container is punctured, work done by the gas is

- (A) Positive (B) Negative (C) Zero (D) ∞

Q.3 The molecular weight of a mixture is 38.4 gm/mol. The mixture is composed of methane and carbon-dioxide gases. The atomic weights of the elements C, H, and O are 12, 1, and 16 gm/mol, respectively. The mole fraction of methane (X_{methane}) is _____ and that of carbon-dioxide ($X_{\text{carbon-dioxide}}$) is _____.

- (A) $X_{\text{methane}} = 0.2$; $X_{\text{carbon-dioxide}} = 0.8$
(B) $X_{\text{methane}} = 0.8$; $X_{\text{carbon-dioxide}} = 0.2$
(C) $X_{\text{methane}} = 0.3$; $X_{\text{carbon-dioxide}} = 0.7$
(D) $X_{\text{methane}} = 0.7$; $X_{\text{carbon-dioxide}} = 0.3$

Q.4 A system undergoes a change from state 1 to state 2. During this process, the change in the internal energy is ΔU . The change in internal energy of the system when executing the cycle 1-2-1 is equal to

- (A) ΔU (B) $2\Delta U$ (C) Zero (D) $-2\Delta U$

Q.5 Which among the following plots represents a line joining two states with the same dew point temperature on a standard psychrometric chart, with the dry bulb temperature on the X-axis and the humidity ratio on the Y-axis?

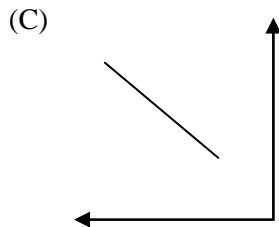
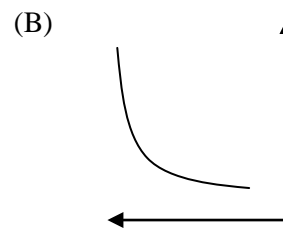
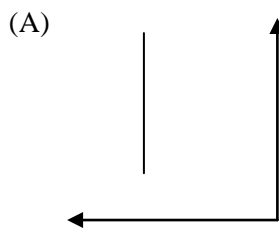

Q.6 The efficiency of a reversible engine operating between two temperatures is 40%. The COP of a reversible refrigerator operating between the same temperatures is

- (A) 1.5 (B) 2.5 (C) 0.4 (D) 3.5

Q.7 For a superheated vapor that cannot be approximated as an ideal gas, the expression determining a small change in the specific internal energy is

(A) $du = c_p dT + \left. \frac{\partial u}{\partial v} \right|_T dv$

(B) $du = c_p dT + \left. \frac{\partial u}{\partial P} \right|_T dP$

(C) $du = c_v dT + \left. \frac{\partial u}{\partial v} \right|_T dv$

(D) $du = c_v dT$

Q.8 The minimum and maximum volumes in an air standard Otto cycle are 100 and 800 cm³. Its thermal efficiency (%) is

- (A) 56.47 (B) 94.55 (C) 54.08 (D) 87.50

Q.9 At a saturation temperature T_{sat} , the difference between the entropy of saturated vapor and entropy of saturated liquid can be expressed as

(A) $(h_f - h_g)/T_{sat}$

(B) $(h_g - h_f)/T_{sat}$

(C) $(u_g - u_f)/T_{sat}$

(D) $(u_f - u_g)/T_{sat}$

Q. 10 – Q. 22 carry two marks each.

Q.10 A gas in a closed system is compressed reversibly from an initial volume of 0.2 m³ to 0.1 m³ at a constant pressure of 3 bar. During this process, there was a heat transfer of 50 kJ from the gas. The change in internal energy of the gas during this process in kJ is

- (A) 20 (B) -80 (C) 80 (D) -20

- Q.11 In a closed rigid vessel, air is initially at a pressure of 0.3 MPa and volume of 0.1 m^3 at 300 K. A stirrer supplies 100 kJ of work to the air, while 20 kJ of heat is lost to the atmosphere across the container walls. After these processes, the temperature of air changes to _____ K.

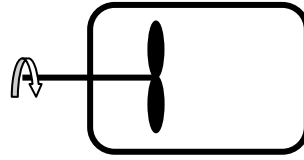

- (A) 321.9 (B) 702.4 (C) 782.4 (D) 620.2
- Q.12 A reversible heat engine (E) operates using three thermal reservoirs with temperatures as shown in the following figure. If $Q_1=Q_2$, the efficiency of the engine is _____.

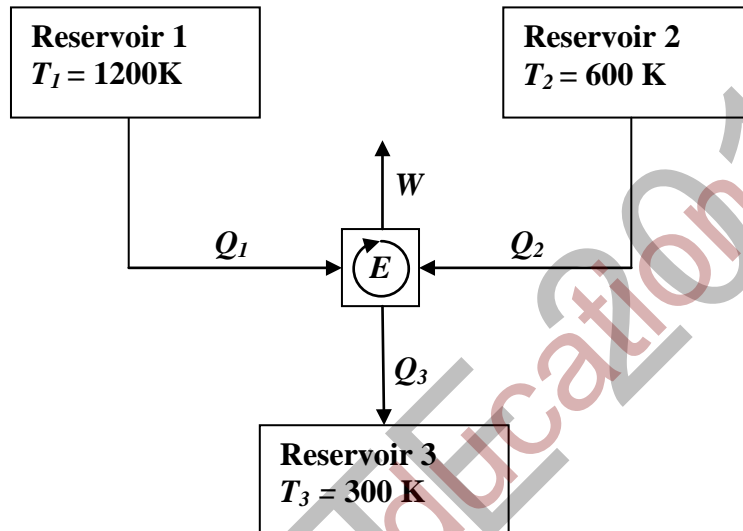

- (A) 0.25 (B) 0.125 (C) 0.625 (D) 0.75
- Q.13 A metal block of mass 25 kg at 300 K is immersed in an infinitely large liquid nitrogen bath maintained at 77 K. The system comprising of the block and liquid nitrogen attains thermal equilibrium. The average specific heat of the metal is 0.45 kJ/(kg.K). The entropy generated during the process is _____ kJ/K.
- (A) 17.28 (B) 32.5 (C) 47.8 (D) -47.8
- Q.14 For a gas obeying the equation of state given by $\left(P + \frac{a}{v^2}\right)v = RT$, the values of the critical volume and the critical temperature are $0.004 \text{ m}^3/\text{kg}$ and $100 \text{ }^\circ\text{C}$, respectively. If the value of the gas constant is $250 \text{ J}/(\text{kg.K})$, then the value of the constant 'a' is _____ ($\text{N.m}^4/\text{kg}^2$). Note that the critical point is the point of inflection on the critical isotherm.

- (A) 124.3 (B) 0.75 (C) 186.58 (D) 248.67

- Q.15 A rigid closed vessel is initially filled with 2 kg of water which is a mixture of saturated liquid and saturated vapor states at 2 bar. The vessel is placed in an oven which heats the mixture to the critical state. Using the saturated and critical property values from the table given below, the heat transferred from the oven to the vessel is _____ kJ.

Pressure = 2 bar			
v_f (m ³ /kg)	v_g (m ³ /kg)	u_f (kJ/kg)	u_g (kJ/kg)
0.0010605	0.8857	504.49	2529.5
Critical pressure			
	v_c (m ³ /kg)	u_c (kJ/kg)	
	0.003155	2029.6	

- (A) 3035.8 (B) 3040.6 (C) 3036.2 (D) 3044.9
- Q.16 The equation of state for a certain gas is given by $v = RT/P - C_1/T^2 + C_2$, where C_1 is 50,000 (K².m³)/kg and C_2 is 0.8 m³/kg. The relation $\left. \frac{\partial h}{\partial P} \right|_T = v - T \left. \frac{\partial v}{\partial T} \right|_P$ is known for the gas. The inversion temperature, given by the condition, $\left[\left. \frac{\partial h}{\partial P} \right|_T = 0 \right]$ is _____ K.
- (A) 500.0 (B) 433.0 (C) 353.6 (D) 250.0
- Q.17 The maximum pressure and temperature in an air standard diesel cycle are 44 bar and 1600 K, respectively. If the minimum pressure and temperature are 1 bar and 300 K, respectively, then the cut-off ratio (the ratio of the volume at the end of the heat addition process to that at the beginning of the heat addition process) is
- (A) 1.000 (B) 14.920 (C) 2.809 (D) 1.809
- Q.18 The thermal efficiency of an air standard Brayton cycle 0.35. The pressure ratio across the turbine is
- (A) 4.516 (B) 5.232 (C) 7.535 (D) 8.234
- Q.19 Steam is isentropically expanded in a turbine from 80 bar to 7 bar. At the inlet of the turbine (state 1) h_1 is 3246 kJ/kg and s_1 is 6.52 kJ/(kg.K).

Pressure = 7 bar			
h_f (kJ/kg)	h_g (kJ/kg)	s_f [kJ/(kg.K)]	s_g [kJ/(kg.K)]
697	2763	2.0	6.7

The enthalpy of the steam exiting the turbine (state 2) in kJ/kg is

- (A) 2683.87 (B) 2657.17 (C) 1986.87 (D) 3354.17

- Q.20 A thin insulating membrane separates two tanks initially filled with nitrogen [mean $c_v = 21.6$ J/(mol.K)] and carbon-dioxide [mean $c_v = 11.6$ J/(mol.K)] as shown below.

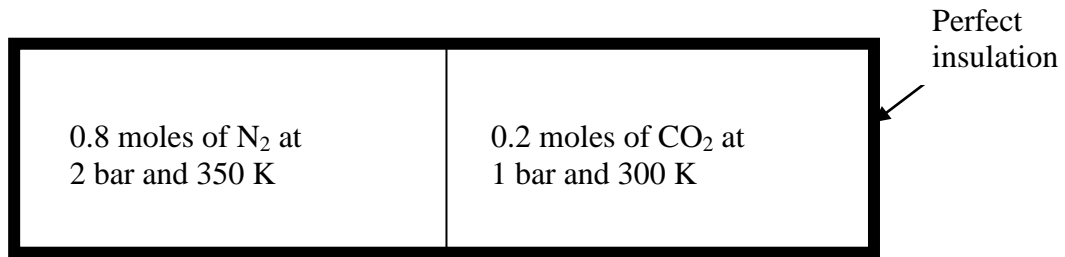

The membrane is ruptured and the gases are allowed to mix to form a homogeneous mixture at equilibrium. During this process there are no heat or work interactions between the tank contents and the surroundings. The final temperature at the equilibrium state in Kelvin is

- (A) 344.1 (B) 306.3 (C) 325.0 (D) 346.1
- Q.21 Two moist air streams MAS1 and MAS2 are mixed adiabatically. The details of MAS1 and MAS2 are given below in the table.

	MAS1	MAS2
h (kJ/kg of dry air)	42	80
v (m^3/kg of dry air)	0.85	0.9
Flow rate (m^3/min)	85	90

With pressure remaining same and with no work interactions during the mixing process, the enthalpy of the mixed stream is _____ kJ/kg of dry air.

- (A) 122 (B) 61 (C) 81 (D) 108
- Q.22 Consider the steady flow of air through an insulated nozzle. The pressure and temperature at the inlet are 120 kPa and 320 K, respectively. The outlet pressure is 1 bar. The inlet velocity is very small and the air undergoes a reversible adiabatic process. The outlet velocity, in m/s, is
- (A) 303.7 (B) 180.7 (C) 5.7 (D) 127.3

END OF THE QUESTION PAPER

F : POLYMER SCIENCE AND ENGINEERING

Q. 1 – Q. 9 carry one mark each.

- Q.1 The estimation of the molecular weight of a polymer by gel permeation chromatography (GPC) is based on its
- (A) polarity (B) size
(C) adsorption to stationary phase (D) crystallinity
- Q.2 Elastomers are characterized by
- (A) high modulus and high elongation at break
(B) high modulus and low elongation at break
(C) low modulus and high elongation at break
(D) low modulus and low elongation at break
- Q.3 Thermodynamically, two polymers with enthalpy of mixing (ΔH) and entropy of mixing (ΔS) form a miscible blend at temperature T when
- (A) $\frac{\Delta H}{\Delta S} = 0.5T$ (B) $\frac{\Delta H}{\Delta S} = T$ (C) $\frac{\Delta H}{\Delta S} = 1.5T$ (D) $\frac{\Delta H}{\Delta S} = 2T$
- Q.4 The tensile strain of a uniformly extending plastic specimen of initial length L_0 and extended length L is
- (A) $\frac{L_0}{L}$ (B) $\frac{L}{L_0}$ (C) $\frac{L_0}{L-L_0}$ (D) $\frac{L-L_0}{L_0}$
- Q.5 In natural rubber compounding, a peptizer is added
- (A) at the beginning of the compounding cycle
(B) after the addition of filler
(C) at the end of the compounding cycle
(D) after the addition of antioxidant
- Q.6 A continuous annular product is produced by
- (A) compression molding (B) extrusion
(C) blow molding (D) injection molding
- Q.7 Relate the three varieties of polyethylene in the left column with their chain structures given in the right column.
- | | |
|----------|-----------------------------------|
| P. HDPE | 1. long as well as short branches |
| Q. LDPE | 2. only short branches |
| R. LLDPE | 3. no branches |
- (A) P-1, Q-3, R-2 (B) P-3, Q-2, R-1 (C) P-2, Q-3, R-1 (D) P-3, Q-1, R-2
- Q.8 Match the following changes observed in the calorimetric analysis of a polymer sample when heat flow (y-axis) is plotted against temperature (x-axis):
- | | |
|-------------------------------|---------------------|
| P. step increase in heat flow | 1. crystallization |
| Q. exothermic peak | 2. melting |
| R. endothermic peak | 3. glass transition |
- (A) P-1, Q-2, R-3 (B) P-2, Q-1, R-3 (C) P-3, Q-1, R-2 (D) P-3, Q-2, R-1

Q.9 A Bingham plastic fluid is flowing under gravity, down a vertical plate, as a film. Find the appropriate match for the fully developed velocity profile of the fluid in the film, from among those shown below.

(A)

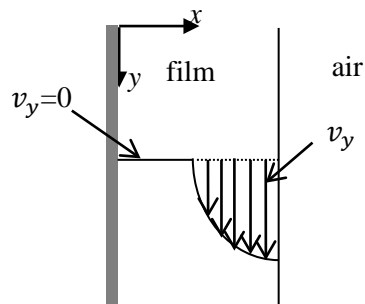

(B)

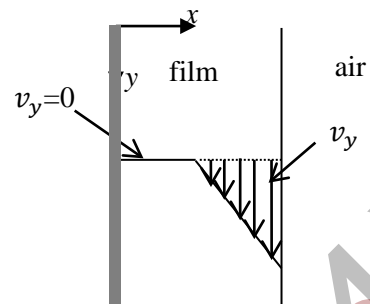

(C)

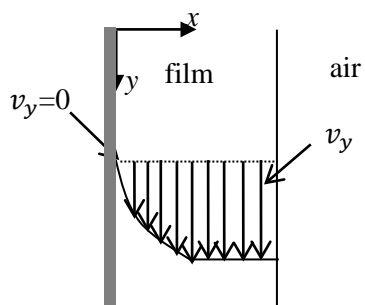

(D)

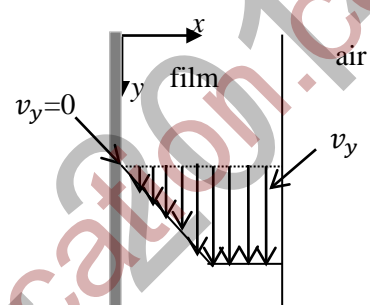

Q. 10 – Q. 22 carry two marks each.

- Q.10 Calculate the mass percent of the crystalline phase in a polymer sample of density 975 kg/m^3 . The density of amorphous phase is 866 kg/m^3 and that of the crystalline phase is 996 kg/m^3 .
- Q.11 Find the rate of initiation ($\text{molL}^{-1}\text{s}^{-1}$) of a polymerization reaction using a peroxide initiator with a half life of 0.1 s and efficiency of 70% , if the concentration of the initiator is 0.05 molL^{-1} .
- Q.12 The constitutive equation of a shear thinning polymeric fluid is given by

$$\sigma = \frac{\mu_0 \dot{\gamma}}{1 + (\dot{\gamma}/\dot{\gamma}_0)}$$

where σ represents shear stress (Pa), and $\dot{\gamma}$, the corresponding shear rate (s^{-1}). The quantities $\mu_0 = 20 \text{ Pas}$ and $\dot{\gamma}_0 = 10 \text{ s}^{-1}$ are constants. Find the apparent viscosity of the sample (Pas) when the applied shear rate is 40 s^{-1} .

- Q.13 Identify the monomer for the polymer shown below prepared by ring opening metathesis polymerization.

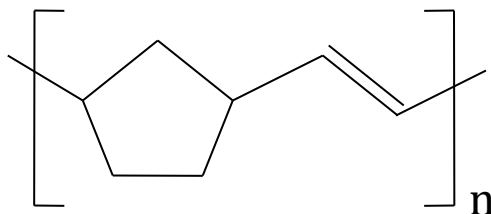

- (A)
- (B)
- (C)
- (D)

- Q.14 The most appropriate order of toughness of nylon based materials is

- (A) talc filled nylon < dry nylon < wet nylon
 (B) dry nylon < wet nylon < talc filled nylon
 (C) wet nylon < dry nylon < talc filled nylon
 (D) wet nylon < talc filled nylon < dry nylon

- Q.15 The shear rates involved in calendaring ($\dot{\gamma}_{cal}$), compression molding ($\dot{\gamma}_{comp}$), extrusion ($\dot{\gamma}_{ext}$), and injection molding ($\dot{\gamma}_{inj}$) processes follow the order

- (A) $\dot{\gamma}_{inj} < \dot{\gamma}_{cal} < \dot{\gamma}_{ext} < \dot{\gamma}_{comp}$ (B) $\dot{\gamma}_{comp} < \dot{\gamma}_{ext} < \dot{\gamma}_{cal} < \dot{\gamma}_{inj}$
 (C) $\dot{\gamma}_{comp} < \dot{\gamma}_{inj} < \dot{\gamma}_{ext} < \dot{\gamma}_{cal}$ (D) $\dot{\gamma}_{comp} < \dot{\gamma}_{cal} < \dot{\gamma}_{ext} < \dot{\gamma}_{inj}$

- Q.16 The dynamic mechanical response of a thermoplastic automotive component has shown a loss angle of 45° and storage modulus of 3500 MPa. Calculate the loss modulus (MPa) of the component.

- Q.17 Match the terms in Column A with the appropriate terms in Column B:

Column A
 P. processability
 Q. moisture permeation
 R. hardness
 S. fracture toughening

Column B
 1. Rockwell scale
 2. rubber modification
 3. melt flow index
 4. Fick's law

- (A) P-3; Q-4; R-2; S-1 (B) P-3; Q-4; R-1; S-2
 (C) P-4; Q-3; R-1; S-2 (D) P-4; Q-3; R-2; S-1

Q.18 Match the following additives for plastics with their respective functions:

<u>Additive</u>	<u>Function</u>
P. dilaurylthiodipropionate	1. solid layer lubricant
Q. graphite	2. flame retardant
R. antimony trioxide	3. reinforcement
S. carbon fibre	4. antioxidant

(A) P-4; Q-1; R-2; S-3
(B) P-1; Q-4; R-2; S-3
(C) P-4; Q-1; R-3; S-2
(D) P-1; Q-4; R-3; S-2

3/4

Q.19 Match the following catalyst/initiator with the type of polymerization reaction:

<u>Catalyst/initiator</u>	<u>Polymerization reaction</u>
P. butyl lithium	1. Ziegler-Natta
Q. $\text{TiCl}_4 + \text{Et}_3\text{Al}$	2. cationic
R. CuBr	3. anionic
S. H_2SO_4	4. atom transfer radical polymerization

(A) P-2; Q-1; R-4; S-3
(B) P-2; Q-4; R-1; S-3
(C) P-3; Q-1; R-4; S-2
(D) P-3; Q-4; R-1; S-2

Q.20 For AIBN (mol. wt. = 164 gmol^{-1}) initiated free radical polymerization of methyl methacrylate (mol. wt. = 100 gmol^{-1}), where the termination is only by radical coupling, the \overline{M}_n of PMMA is found to be 4636 gmol^{-1} . Calculate the degree of polymerization.

Q.21 A polymer solution is made by dissolving 5 g of polymer in 1000 ml of solvent. The flow time of the solvent and that of the polymer solution between two appropriate marks in a viscometer are 40 s and 60 s, respectively. The reduced viscosity (in dLg^{-1}) of the polymer solution is:

- (A) 0.25 (B) 0.50 (C) 1.0 (D) 1.5

Q.22 The volume resistivity of a polymeric material is $10^7 \Omega\text{m}$. Find the resistance (in $\text{M}\Omega$) of a cube of the material of side 1 cm. The direction of current flow is as shown in the figure below.

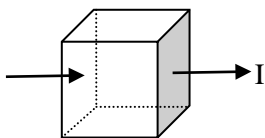

END OF THE QUESTION PAPER

XE (GATE 2014)
www.sakshieducation.com

G: FOOD TECHNOLOGY

Q. 1 – Q. 9 carry one mark each.

Q.1 The systematic name of sucrose is

- (A) α -D-Fructofuranosyl (1 \rightarrow 2) β -D-Glucopyranoside
 (B) α -D-Glucopyranosyl (1 \rightarrow 2) β -D-Fructofuranoside
 (C) α -D-Glucopyranosyl (2 \rightarrow 1) β -D-Fructofuranoside
 (D) α -D-Fructofuranosyl ((2 \rightarrow 1) β -D-Glucopyranoside

Q.2 A non-hydrolyzable lipid is

- (A) Lecithin (B) Arachidic acid (C) Tocopherol (D) Tristearin

Q.3 The respiratory quotient (RQ) for the reaction $2 C_{57}H_{110}O_6 + 163 O_2 \rightarrow 114 CO_2 + 110 H_2O$ is

- (A) 0.70 (B) 1.14 (C) 1.43 (D) 0.14

Q.4 Liver necrosis may be caused by the deficiency of

- (A) Vitamin A (B) Vitamin D (C) Vitamin K (D) Vitamin E

Q.5 Which of the following non-nutritive sweeteners contains similar calories per gram as that of sucrose?

- (A) Saccharin (B) Aspartame (C) Sucralose (D) Cyclamate

Q.6 The objective of heating milk to about 65°C before homogenization is to inactivate

- (A) Glucose oxidase (B) Lipases (C) Lactases (D) Invertases

Q.7 Make the correct match of the processes in **Column I** with the suitable materials/products in **Column II**

Column I

- 1) Rendering
- 2) Hydrogenation
- 3) Degumming
- 4) Bleaching

Column II

- P) Lecithin
- Q) Fullers' earth
- R) Lard
- S) Margarine

(A) 1-R, 2-P, 3-Q, 4-S

(B) 1-P, 2-Q, 3-S, 4-R

(C) 1-R, 2-P, 3-S, 4-Q

(D) 1-R, 2-S, 3-P, 4-Q

Q.8 A fruit juice of viscosity μ and density ρ is agitated using an impeller of diameter D at a speed of N revolutions per minute. The terms $X = \frac{P}{\rho N^3 D^5}$, $Y = \frac{D^2 N \rho}{\mu}$, $Z = \frac{N^2 D}{g}$ represent three process related numbers, where P is power imparted by impeller and g is acceleration due to gravity. Which of the following is correct representation of these numbers?

- (A) $X = \text{Power}$, $Y = \text{Froude}$, $Z = \text{Reynolds}$ (B) $X = \text{Power}$, $Y = \text{Reynolds}$, $Z = \text{Froude}$
 (C) $X = \text{Froude}$, $Y = \text{Reynolds}$, $Z = \text{Power}$ (D) $X = \text{Reynolds}$, $Y = \text{Power}$, $Z = \text{Froude}$

Q.9 The energy required to reduce the size of a food material from a mean diameter of 12 mm to 4 mm is 10 kJ kg⁻¹. From Rittingers' law, the energy needed to reduce the same material from a diameter of 1.2 mm to 0.4 mm in kJ kg⁻¹ is _____

Q. 10 – Q. 22 carry two marks each.

Q.10 *Saccharomyces cerevisiae* (mean doubling time 3.2 h) is grown in a batch fermenter with an operating volume of 12 m³. A 2% (v/v) inoculum, which contains 5 kg cells per 100 m³ is mixed with the substrate. The residence time in the fermenter is 24 h and the density of broth is 1010 kg m⁻³. The mass of *S. cerevisiae* obtained from the fermenter, in kg, is _____

Q.11 Make the correct combination of operations in **Column I** with the machines in **Column II**

Column I

- 1) Rice milling
- 2) Wheat milling
- 3) Mustard oil expelling
- 4) Pepper grinding

Column II

- P) Pin mill
- Q) Rubber rolls
- R) Break rolls
- S) Screw press

- (A) 1-Q, 2-R, 3-S, 4-P (B) 1-R, 2-Q, 3-S, 4-P
 (C) 1-Q, 2-P, 3-S, 4-R (D) 1-Q, 2-R, 3-P, 4-S

Q.12 The correct order for D_{121} values of the spores of food spoilage bacteria in aqueous medium is

- (A) *B. stearothermophilus* > *C. sporogenes* > *C. botulinum* type A > *B. coagulans*
 (B) *C. sporogenes* > *B. stearothermophilus* > *C. botulinum* type A > *B. coagulans*
 (C) *C. botulinum* type A > *B. stearothermophilus* > *C. sporogenes* > *B. coagulans*
 (D) *B. stearothermophilus* > *C. botulinum* type A > *C. sporogenes* > *B. coagulans*

Q.13 Make the correct combination of pigments/microorganisms in **Column I** with the process/ products in **Column II**

Column I

- 1) Anthocyanin
- 2) Chlorophyll
- 3) *Bacillus subtilis*
- 4) *Aspergillus oryzae*

Column II

- P) Ropiness
- Q) Koji
- R) Glycosides
- S) Porphyrins

- (A) 1-S, 2-R, 3-P, 4-Q (B) 1-R, 2-S, 3-Q, 4-P
 (C) 1-Q, 2-S, 3-P, 4-R (D) 1-R, 2-S, 3-P, 4-Q

Q.14 Make the correct combination of underlying principles in **Column I** with the processes in **Column II**

Column I

- 1) Carbonyl derivatives react with free amino acids to yield aldehydes
- 2) Starch aggregates and forms micro-crystals
- 3) Starch granules swell and leach amylose
- 4) Pyranose or furanose rings open up by pyrolytic reactions to form furfural derivatives

Column II

- P) Gelatinization
- Q) Strecker degradation
- R) Caramelization
- S) Retrogradation

(A) 1-Q, 2-R, 3-P, 4- S

(B) 1-Q, 2-S, 3-P, 4-R

(C) 1-R, 2-S, 3-P, 4- Q

(D) 1-Q, 2-P, 3- S, 4-R

Q.15 Which one of the following statements is **FASLE**?

- (A) The peptide bond is planar offering restricted rotation around its axis.
- (B) Full range of water activity is $0 \leq a_w \leq 1$ and it has well defined unit.
- (C) The autooxidation of lipids proceeds via free radical mechanism.
- (D) The carbonyl group of sugar reacts with nucleophilic amino group of amino acids in Amadori rearrangement.

Q.16 Which one of the following statements is **TRUE**?

- (A) Pectate lyase hydrolyzes methyl ester bond of pectin.
- (B) α -Solanine is a non-toxic compound found in solanaceae plants.
- (C) Egg proteins have lower digestibility than pea proteins.
- (D) Lipoxygenase catalyses the conversion of cis, cis-1,4-pentadiene to hydroperoxides.

Q.17 Fish fillet having 84% moisture (wet basis) is frozen from top using an air blast freezer maintained at -32°C . The initial temperature of the fillet (density 1050 kg m^{-3}) is -2°C (freezing point). Convective heat transfer coefficient of air is $25 \text{ W m}^{-2} \text{ K}^{-1}$, thermal conductivity of frozen fish is $1.0 \text{ W m}^{-1} \text{ K}^{-1}$ and latent heat of crystallization is 340 kJ kg^{-1} . The freezing time, in min, for a 20 mm thick block of fish fillet weighing 1 kg is _____

Q.18 Make the correct combination of properties in **Column I** with their dimensions in **Column II**

Column I

- 1) Dynamic viscosity
- 2) Thermal conductivity
- 3) Specific heat
- 4) Force

Column II

- P) $\text{m}^2 \text{ s}^{-2} \text{ K}^{-1}$
- Q) kg m s^{-2}
- R) $\text{kg m}^{-1} \text{ s}^{-1}$
- S) $\text{kg m s}^{-3} \text{ K}^{-1}$

(A) 1-R, 2-S, 3-Q, 4- P

(B) 1- Q, 2-S, 3-P, 4- R

(C) 1-R, 2-S, 3-P, 4-Q

(D) 1- S, 2-R, 3-P, 4-Q

Q.19 The viscosity and density of a fruit juice at 21°C are 6.3×10^{-3} Pa s and 1029 kg m^{-3} , respectively. The juice flows at the rate of $0.12 \text{ m}^3 \text{ min}^{-1}$ in a 2.54 cm inner diameter steel pipe. Correct combination of the Reynolds number (N_{Re}) and the nature of flow of juice is

(A) $N_{Re} = 1048$, Laminar

(B) $N_{Re} = 2056$, Laminar

(C) $N_{Re} = 16375$, Turbulent

(D) $N_{Re} = 28656$, Turbulent

Q.20 For a typical food sorption isotherm curve (Figure 1), which one of the following statements is **CORRECT** ?

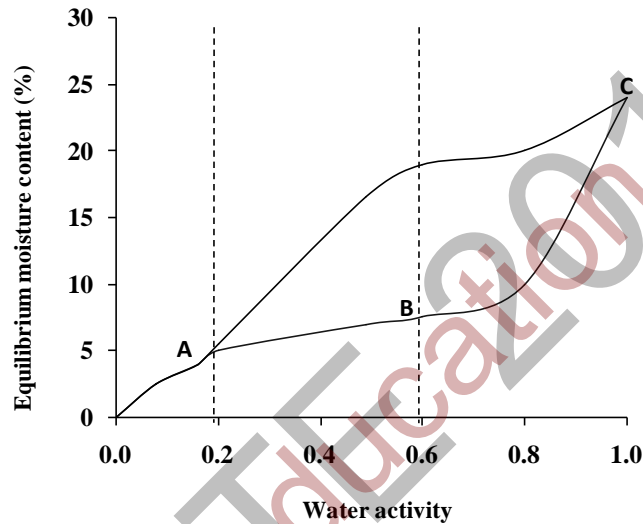

Figure 1: Food sorption isotherm curve

- (A) Y-coordinate of A represents monolayer water content of food, A-B represents water absorbed in the multilayer within the food and B-C represents free water within the capillary network of the food.
- (B) Y-coordinate of B represents monolayer water content of food, A-B represents water absorbed in the multilayer within the food and B-C represents free water within the capillary network of the food.
- (C) Y-coordinate of A represents monolayer water content of food, Y-coordinate of B represents water absorbed in the multilayer within the food and B-C represents free water within the capillary network of the food.
- (D) Y-coordinate of A represents monolayer water content of food, A-C represents water absorbed in the multilayer within the food and Y-coordinate of C represents free water within the capillary network of the food.

- Q.21 10,000 kg milk (7% fat) is passed through a cream separator to obtain cream (40% fat) and skim milk (0.1 % fat). The cream, thus obtained, is churned to make butter of 80.5% fat. If a loss of 0.5% of initial milk fat occurs during the manufacturing process, the % overrun is _____
- Q.22 A 50 mm thick pack of farm fresh berries is cooled at one side from 24°C to 7°C. The relevant properties of berries are: density 1025 kg m⁻³, specific heat 3.78 kJ kg⁻¹K⁻¹, convective heat transfer coefficient 30 Wm⁻²K⁻¹, and thermal conductivity 0.3 Wm⁻¹ K⁻¹. The Fourier number for a cooling span of 30 min is _____

END OF THE QUESTION PAPER