

Sr.No. 41179

E

**2013 (I)
ENGINEERING SCIENCES
TEST BOOKLET**

SUBJECT CODE BOOKLET CODE

6

A

Time : 3:00 Hours

Maximum Marks: 200

INSTRUCTIONS

1. This Test Booklet contains one hundred and fifteen (20 Part 'A'+ 25 Part 'B' + 70 Part 'C') Multiple Choice Questions (MCQs). You are required to answer a maximum of 15, 20 and 20 questions from part 'A' 'B' and 'C' respectively. If more than required number of questions are answered, only first 15, 20 and 20 questions in Parts 'A' 'B' and 'C' respectively, will be taken up for evaluation.
2. Answer sheet has been provided separately. Before you start filling up your particulars, please ensure that the booklet contains requisite number of pages and that these are not torn or mutilated. If it is so, you may request the Invigilator to change the booklet. Likewise, check the answer sheet also. Sheets for rough work have been appended to the test booklet.
3. Write your Roll No., Name; Your address and Serial Number of this Test Booklet on the Answer sheet in the space provided on the side 1 of Answer sheet. Also put your signatures in the space identified.
4. **You must darken the appropriate circles with a pencil related to Roll Number, Subject Code, Booklet Code and Centre Code on the OMR answer sheet. It is the sole responsibility of the candidate to meticulously follow the instructions given on the Answer Sheet, failing which, the computer shall not be able to decipher the correct details which may ultimately result in loss, including rejection of the OMR answer sheet.**
5. Each question in Part 'A' carries 2 marks, Part 'B' 3.5 marks and Part 'C' 5 marks respectively. There will be negative marking @ 25% for each wrong answer.
6. Below each question in Part 'A', 'B' and 'C' four alternatives or responses are given. Only one of these alternatives is the "correct" option to the question. You have to find, for each question, the correct or the best answer.
7. **Candidates found copying or resorting to any unfair means are liable to be disqualified from this and future examinations.**
8. Candidate should not write anything anywhere except on answer sheet or sheets for rough work.
9. After the test is over, you MUST hand over the Test Booklet and the answer sheet (OMR) to the invigilator.
10. Use of scientific calculator without data connectivity is permitted.

Roll No.....

Name

I have verified all the information filled
in by the candidate.

S/46 BJ/13-6AE-1A

.....
Signature of the Invigilator

PART 'A'

1. There is an equilateral triangle in the XY plane with its centre at the origin. The distance of its sides from the origin is 3.5 cm. The area of its circumcircle in cm^2 is

1. 38.5 2. 49
3. 63.65 4. 154

2. A sphere of iron of radius $R/2$ fixed to one end of a string was lowered into water in a cylindrical container of base radius R to keep exactly half the sphere dipped. The rise in the level of water in the container will be

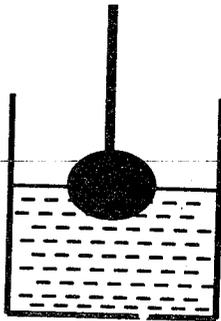

1. $R/3$ 2. $R/4$
3. $R/8$ 4. $R/12$

3. A crystal grows by stacking of unit cells of $10 \times 20 \times 5$ nm size as shown in the diagram given below. How many unit cells will make a crystal of 1cm^3 volume?

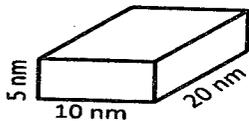

Unit Cell (not to scale)

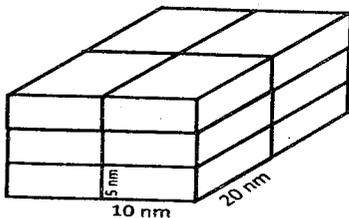

Crystal (not to scale)

1. 10^6 2. 10^9
3. 10^{12} 4. 10^{18}

4. What is the value of $\frac{1}{1 \times 2} + \frac{1}{2 \times 3} + \frac{1}{3 \times 4} + \dots$ to ∞ ?

1. $2/3$ 2. 1
3. 2 4. ∞

5. A solid cylinder of basal area A was held dipped in water in a cylindrical vessel of basal area $2A$ vertically such that a length h of the cylinder is immersed. The lower tip of the cylinder is at a height h from the base of the vessel. What will be the height of water in the vessel when the cylinder is taken out?

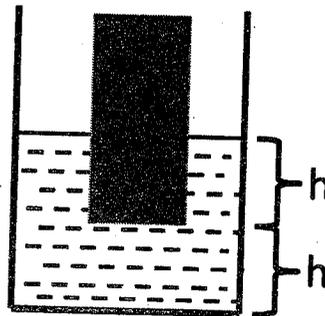

1. $2h$ 2. $\frac{3}{2}h$
3. $\frac{4}{3}h$ 4. $\frac{5}{4}h$

6. Of all the triangles that can be inscribed in a semicircle of radius R with the diameter as one side, the biggest one has the area

1. R^2 2. $R^2\sqrt{2}$
3. $R^2\sqrt{3}$ 4. $2R^2$

7. Choose the largest number:

1. 2^{500} 2. 3^{400}
3. 4^{300} 4. 5^{200}

8. A daily sheet calendar of the year 2013 contains sheets of 10×10 cm size. All the sheets of the calendar are spread over the floor of a room of $5m \times 7.3m$ size. What percentage of the floor will be covered by these sheets?

- 1. 0.1
- 2. 1
- 3. 10
- 4. 100

9. How many rectangles (which are not squares) are there in the following figure?

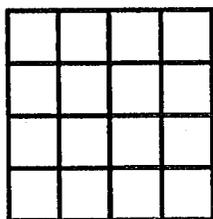

- 1. 56
- 2. 70
- 3. 86
- 4. 100

10. Define $a \otimes b = \text{lcm}(a,b) + \text{gcd}(a,b)$ and $a \oplus b = a^b + b^a$. What is the value of $(1 \oplus 2) \otimes (3 \oplus 4)$? Here lcm = least common multiple and gcd = greatest common divisor.

- 1. 145
- 2. 286
- 3. 436
- 4. 572

11. A square pyramid is to be made using a wire such that only one strand of wire is used for each edge. What is the minimum number of times that the wire has to be cut in order to make the pyramid?

- 1. 3
- 2. 7
- 3. 2
- 4. 1

12. A crow is flying along a horizontal circle of radius R at a height R above the horizontal ground. Each of a number of men on the ground found that the angular height of the crow was a fixed angle θ ($< 45^\circ$) when it was closest to him. Then all these men must be on a circle on the ground with a radius

- 1. $R + R \sin \theta$
- 2. $R + R \cos \theta$
- 3. $R + R \tan \theta$
- 4. $R + R \cot \theta$

13. How many pairs of positive integers have gcd 20 and lcm 600? (gcd = greatest common divisor; lcm = least common multiple)

- 1. 4
- 2. 0
- 3. 1
- 4. 7

14. During an evening party, when Ms. Black, Ms. Brown and Ms. White met, Ms. Brown remarked, "It is interesting that our dresses are white, black or brown, but for each of us the name does not match the colour of the dress!". Ms. White replied, "But your white dress does not suit you!". Pick the correct answer.

- 1. Ms White's dress was brown.
- 2. Ms. Black's dress was white.
- 3. Ms. White's dress was black.
- 4. Ms. Black's dress was black.

15. Two integers are picked at random from the first 15 positive integers without replacement. What is the probability that the sum of the two numbers is 20?

- 1. $\frac{3}{4}$
- 2. $\frac{1}{21}$
- 3. $\frac{1}{105}$
- 4. $\frac{1}{20}$

16. Identify the next figure in the sequence

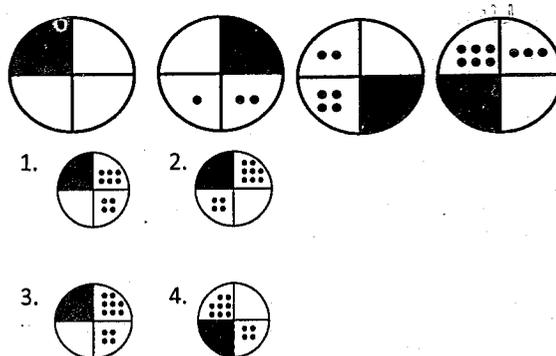

17. In a customer survey conducted during Monday to Friday, of the customers who asked for child care facilities in super markets, 23% were men and the rest, women. Among them, 19.9% of the women and 8.8% of the men were willing to pay for the facilities.

- What is the ratio of the men to women customers who wanted child care facilities?
- If the survey had been conducted during the weekend instead, how will the result change?

With the above data,

- Only A can be answered
- Only B can be answered
- Both A and B can be answered
- Neither A nor B can be answered

18. The map given below shows contour lines which connect points of equal ground surface elevation in a region. Inverted 'V' shaped portions of contour lines represent a valley along which a river flows. What is the downstream direction of the river?

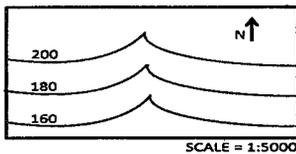

- North
- South
- East
- West

19. During a summer vacation, of 20 friends from a hostel, each wrote a letter to each of all others. The total number of letters written was

- 20
- 400
- 200
- 380

20.

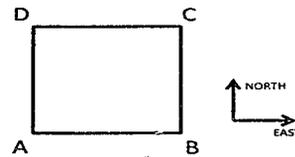

A person has to cross a square field by going from A to C. The person is only allowed to move towards the east or towards the north or use a combination of these movements. The total distance travelled by the person

- depends on the length of each step
- depends on the total number of steps
- is different for different paths
- is the same for all paths

PART 'B'**MATHEMATICS**

21. Consider the differential equation $\frac{dy}{dx} = y' = (3x^2 + 2x)e^{(y-x)} + 1$. If $y(1) = 1$ then $y(0)$ is

- (1) $-\ln 3$ (2) 0 (3) 1 (4) $\ln 2$

22. Consider the differential equation $y'' - y = 2e^x$. If $y(0) = y'(0) = 0$, then $y(1)$ is

- (1) $e + \sinh [1]$ (2) $\sinh [1]$ (3) $\cosh [1]$ (4) $\cosh[1] + 1$

23. Let $\beta = e^{\frac{\pi i}{10}}$. The residue of the function $f(z) = \frac{1}{1+z^{10}}$ at $z = \beta$ is

- (1) $\frac{-\beta}{10}$ (2) $\frac{\beta}{10}$ (3) $\frac{-\pi i \beta}{5}$ (4) $\frac{\pi i \beta}{5}$

24. If $f(x) = \left(e^{\frac{1}{5x}} - 1\right) \left(5x + \frac{x}{5} \sin \frac{1}{x}\right)$, then $\lim_{x \rightarrow \infty} f(x)$

- (1) exists and is equal to -1 (2) exists and is equal to 0
(3) exists and is equal to 1 (4) does NOT exist

25. The value of the integral

$$\int_0^{\pi/2} \int_x^{\pi/2} \frac{\cos y}{y} dy dx$$

is

- (1) $-\frac{1}{2}$ (2) -1 (3) $\frac{1}{2}$ (4) 1

26. Let D be the triangular region in \mathbb{R}^2 bounded by the y -axis, the line $y = 1$ and the line $y = x$. Let C be the boundary curve of the region and C be oriented counter-clockwise. Then the value of the line integral

$$\int_C (x^2 + 2\sin^2 x \cos x) dx + (4x + y^2) dy$$

is

- (1) 1 (2) 2 (3) 4 (4) 8

27. Let A be a 3×3 real matrix. Suppose 1 and -1 are two of the three eigenvalues of A and 18 is one of the eigenvalues of $A^2 + 3A$. Then

- (1) both A and $A^2 + 3A$ are invertible
(2) $A^2 + 3A$ is invertible but A is NOT invertible
(3) A is invertible but $A^2 + 3A$ is NOT invertible
(4) both A and $A^2 + 3A$ are NOT invertible

32. A coal fired power plant operates on the Rankine cycle and has a thermal efficiency of 30%. The heat input to the boiler is measured to be 500 MW. The pump input power is negligibly small. If the condenser is cooled by sea-water ($c_p=1.0$ kJ/kgK) which is available at 20°C, and if the measured exit temperature of the cooling water for the condenser is 30°C, the mass flow rate of sea-water required for the condenser (in kg/s) will be

(1) 1,236 (2) 5,000 (3) 15,000 (4) 35,000

33. A conducting path on an IC chip is 3.2 millimeters long and has a rectangular cross section 1×5 micrometers. A current of 5mA produces a voltage drop of 100 mV across the line. If the electron mobility is 500 cm²/V-s, then the electron concentration (in cm⁻³) is

(1) 8×10^{10} (2) 4×10^{21} (3) 8×10^{20} (4) 4×10^{22}

34. A typical transistor amplifier (shown below) is operating in its active region with sinusoidal input current at the base. The maximum and minimum collector currents are 10 mA and 1 mA, respectively. The maximum and minimum collector voltages are 9V and 1V, respectively. What is the output power?

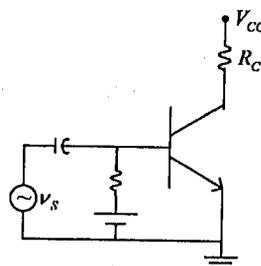

(1) 8 W (2) 10 W (3) 6 W (4) 9 W

35. The engineering stress – strain diagram of a mild steel indicates stress values of 300 MPa and 400 MPa at 10% and 15% strains, respectively, and exhibits necking at a strain of 27%. The difference in true stress values between these points is:

(1) 100 MPa. (2) 120 MPa (3) 130 MPa (4) 140 MP

36. Match the following crystalline defects with their nature

(a) Screw Dislocation (i) Surface Defect
 (b) Frankel Defect (ii) Line Defect
 (c) Plain boundary (iii) Point Defect

(1) a – iii, b – i, c – ii
 (2) a – i, b – iii, c – ii
 (3) a – ii, b – i, c – iii
 (4) a – ii, b – iii, c – i

37. An electrostatic model in a linear isotropic medium has an electric field intensity given by $E = \hat{i}(x + C_1z) + \hat{j}(C_2x - 3z) + \hat{k}(x + C_3y + C_4z)$ where C_1, C_2, C_3, C_4 are constants. Assuming the charge density in the medium is zero, the values of the C_1, C_2, C_3, C_4 are

(1) $C_1 = 0$ $C_2 = 1$ $C_3 = 3$ $C_4 = -1$ (2) $C_1 = 3$ $C_2 = -1$ $C_3 = 1$ $C_4 = 0$
 (3) $C_1 = 1$ $C_2 = 0$ $C_3 = -3$ $C_4 = -1$ (4) $C_1 = 1$ $C_2 = 3$ $C_3 = -1$ $C_4 = 0$

42. Determine the force in the member AC of the truss shown. Use negative sign to indicate compressive force.

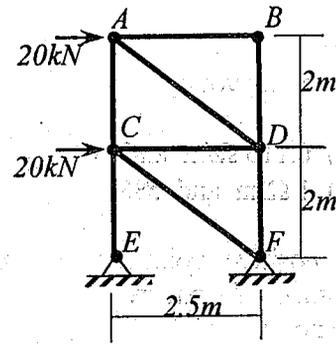

- (1) -16kN (2) 16kN (3) 25kN (4) -25kN
43. Continuity equation for a given velocity field is given by $\frac{\partial}{\partial x}(\rho u) + \frac{\partial}{\partial y}(\rho v) = 0$, where ρ is the fluid density, u is the x -component of flow velocity and v is the y -component of flow velocity.
- The above equation is applicable only for
- (1) Incompressible flow
 (2) Inviscid flow
 (3) Steady and two-dimensional flow
 (4) Two-dimensional and incompressible flow
44. Consider the two-dimensional flow field given in Eulerian description by the expression $\vec{v} = 3y\hat{i} - 2x\hat{j}$, where \hat{i} and \hat{j} are unit vectors along x and y directions, respectively. The streamline shapes corresponding to the flowfield conform to
- (1) circle (2) parabola
 (3) ellipse (4) rectangular hyperbola
45. A car engine burns 5 kg of fuel (with a heating value of 40 MJ/kg) at 1500 K and rejects energy to the radiator and the exhaust gas at an average temperature of 750 K. The maximum amount of work (in MJ) the engine can provide is
- (1) 20 (2) 40 (3) 100 (4) 200

PART 'C'**THERMODYNAMICS**

46. The figure shows a reversible cycle comprising three processes (1-2, 2-3 and 3-1) executed by 0.5 kg of a gas. The net heat transfer (in kJ) of the cycle is

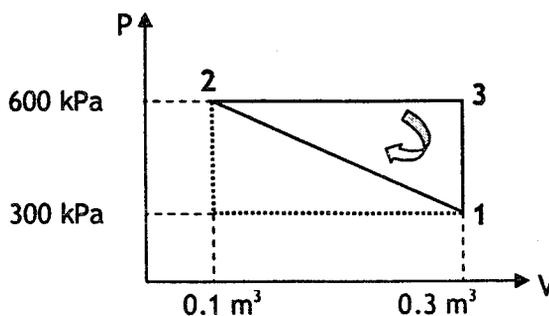

- (1) 15 (2) 30 (3) 60 (4) 120
47. A stationary insulated rigid tank contains 1 kg of an ideal gas with constant specific heats ($c_v=0.7$ kJ/kgK and $c_p=1.0$ kJ/kgK) at 27°C and 300 kPa. A paddle wheel with a power capacity of 20 W is operated inside the tank for 15 minutes. The final pressure of air (in kPa) in the tank will be

- (1) 100.7 (2) 225.7 (3) 318.7 (4) 325.7

48. An ideal gas, having a specific gas constant of 0.3 kJ/kgK and a specific heat ratio (γ) of 1.4, is in a frictionless piston-cylinder assembly, as shown in the figure. The gas is initially at 600 K and is expanded to twice the initial volume and then the piston is locked with a pin. The specific heat transfer (in kJ/kg) during the process is

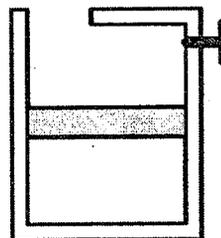

- (1) 180 (2) 450 (3) 630 (4) 810
49. An insulated rigid tank is divided into two compartments by a partition. One component contains 5 kmol of O_2 and the other compartment contains 5 kmol of CO_2 . Both gases are initially at 27°C and 200 kPa. Now the partition is removed and the two gases are allowed to mix. The surroundings are at 27°C and both gases behave as ideal gases. Given: $R_u=8.314$ kJ/kmol-K. The exergy destruction (in MJ) associated with this process is

- (1) 17.3 (2) 10.5 (3) 2.1 (4) 1.6

50. It is proposed that a solar powered engine will operate on the Carnot cycle using ammonia as the working fluid. Heat addition is to occur at 50°C (transforming saturated liquid to dry saturated vapour) with heat rejection at 20°C . Given specific entropy data in kJ/kgK: s_g at $50^\circ\text{C} = 4.761$; at 20°C , $s_f = 1.041$ and $s_g = 5.086$; Enthalpy values: at 50°C , $h_f = 421.5$ kJ/kg and $h_g = 1471.6$ kJ/kg. The net work output of the cycle in kJ/kg is

- (1) 97.5 (2) 121.4 (3) 242.7 (4) 630.0

51. A person wishes to determine the humidity ratio in air at a high altitude location from the available values of relative humidity and dry bulb temperature using a psychrometric chart. However, by mistake he uses the chart which is meant for sea level. The actual moisture content will be
- (1) less than the determined value
 - (2) more than the determined value
 - (3) same as the determined value
 - (4) more or less than the determined value depending on the wet bulb temperature
52. 2 kg of water at 60°C is mixed thoroughly with 4 kg of water at 30°C in a perfectly insulated tank. Assuming the specific heat of water to be constant ($= 4.18 \text{ kJ/kg.K}$), the entropy generated (in J/K) during this process is
- (1) 0
 - (2) 25.1
 - (3) 101.1
 - (4) 422.6
53. A simple, reverse Brayton cycle using air as the working fluid operates between a maximum heat addition temperature of 27°C and a minimum heat rejection temperature of 47°C . Assume air to behave as an ideal gas with $c_p = 1.005 \text{ kJ/kg.K}$ and $c_v = 0.718 \text{ kJ/kg.K}$. The isentropic efficiency of both turbine and compressor is equal to 0.8. The minimum pressure ratio required for the cycle to produce a finite cooling output is
- (1) 1.07
 - (2) 1.25
 - (3) 1.34
 - (4) 1.56
54. Saturated property data for NH_3 is given below.

P bar	T $^{\circ}\text{C}$	v_f m^3/kg	v_g m^3/kg
0.4	-50.4	1.424×10^{-3}	2.680
0.5	-46.5	1.433×10^{-3}	2.175
0.6	-43.3	1.441×10^{-3}	1.835

The latent heat of vaporization of NH_3 (in kJ/kg) at 0.5 bar is

- (1) 13.87
 - (2) 169.0
 - (3) 473.4
 - (4) 1386.8
55. A domestic refrigerator provides 80 W of refrigeration at -18°C for the freezer and 40 W of refrigeration at 5°C for the fresh food compartment. The refrigerator is placed in a room which is maintained at 35°C . The minimum power input (in W) required for the refrigerator is
- (1) 12.95
 - (2) 18.7
 - (3) 20.94
 - (4) 24.94

ELECTRONICS

56. The Z-transform $X(z)$ of a sequence $x(n)$ is given by

$$X(z) = \frac{z^{18}}{\left(z - \frac{1}{2}\right)(z - 1)(z - 4)}$$

If $X(z)$ converges for $|z| = 1$, then $x(-16)$ is given as

- (1) $\frac{8}{21}$
- (2) $\frac{2}{3}$
- (3) $\frac{1}{7}$
- (4) $\frac{2}{27}$

57. A signal $m(t)$, band limited to a maximum frequency of 30 KHz, is sampled at a frequency f_s KHz. The sampled version of the signal is then passed through an ideal low pass filter having a cutoff frequency of 45 KHz to reconstruct $m(t)$ without distortion. The minimum value of the sampling frequency is
- (1) 60 KHz (2) 75 KHz (3) 90 KHz (4) 150 KHz
58. If a single tone amplitude modulated signal at a modulation depth of 100% transmits a total power of 9 watts, the power (in watts) in one of the side band is
- (1) 1.0 (2) 1.5 (3) 2.5 (4) 3.0
59. In a binary PCM system, the maximum tolerable error in sample amplitude is 0.25% of the peak input amplitude. The input signal bandwidth is 5 MHz. The minimum rate (in Mbits/sec) of transmission of the PCM code bits is
- (1) 60.5 (2) 75.8 (3) 82.4 (4) 89.3
60. For the circuit shown below, what will be the voltage V_A ? Assume the cut-in voltage of each diode to be $0.7V$.

- (1) $-2.15 V$
 (2) $2.15 V$
 (3) $1.15 V$
 (4) $-1.15 V$

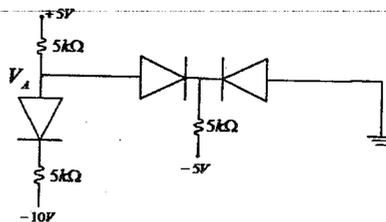

61. For the circuit shown below, what will be the collector voltage V_C ? Transistor parameters are

$$\beta = 100, V_{BE(\text{on})} = 0.7 V$$

- (1) $7.9 V$ (2) $8.3 V$
 (3) $9.5 V$ (4) $8.6 V$

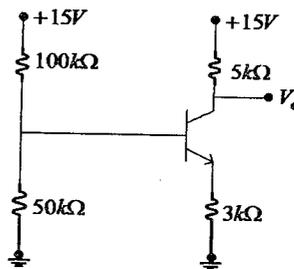

62. For the OPAMP circuit shown below, what will be the closed-loop voltage gain v_o/v_i ?

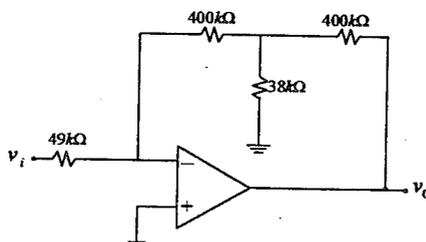

- (1) -204.5 (2) -102.25 (3) 102.25 (4) 204.5

63. A three-variable boolean function, F , is expressed as (A , B and C are the logical variables):

$$F = \Sigma m(2,4,8,9,11,12,13)$$

The minimal sum-of-products expression for this boolean function is

- (1) $A\bar{B}D + C\bar{D}$ (2) $BC\bar{A} + AD$
 (3) $A\bar{B}C\bar{D} + B\bar{C}\bar{D} + A\bar{C} + A\bar{B}D$ (4) $B\bar{C}D + A\bar{D} + \bar{A}C$

64. For the logic circuit shown below, which one of the following expresses the correct input-output relation?

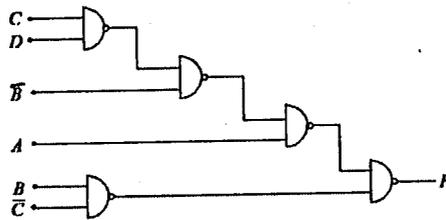

- (1) $\bar{A}BC\bar{D}$ (2) $AC + B\bar{D} + A\bar{B}$
 (3) $AB + CD$ (4) $B\bar{C} + A(B + CD)$

65. For the clocked flip-flop circuit shown below, what is the correct characteristic equation?

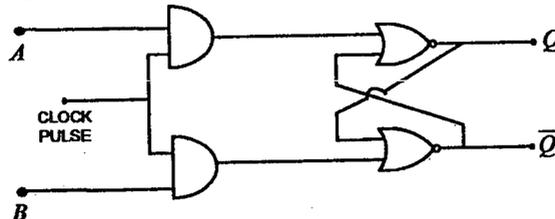

- (1) $Q(t+1) = B + \bar{A}Q, AB = 0$ (2) $Q(t+1) = AQ + \bar{B}, AB = 1$
 (3) $Q(t+1) = A + \bar{B}Q, AB = 1$ (4) $Q(t+1) = Q + A\bar{B}, AB = 0$

MATERIAL SCIENCES

66. The critical crack extension force of a material increases by 30% when the thickness of a component decreases in a manner that a crack experiences variation in the stress field from plane strain to plane stress condition. If the Poisson's ratio of the material is 0.3, the stress bearing capacity would:

- (1) increase by 18.3% (2) decrease by 18.3%
 (3) increase by 8.76% (4) decrease by 8.76%

67. A cylindrical tensile specimen of gauge length of 25 mm and gauge diameter of 6 mm was tested till fracture. The specimen exhibits reduction in area of 26% at the end of the test. The true strain at fracture for the specimen is close to:

- (1) 0.24 (2) 0.27 (3) 0.30 (4) 0.33

74. The melting point and the enthalpy of fusion of Sn are 232°C and $0.42 \times 10^9 \text{ J/m}^3$, respectively. In this system, appreciable nucleation occurs only when Gibb's free energy of the critical nucleus drops below $1.5 \times 10^{-19} \text{ J}$. The solid-liquid interfacial energy is 0.055 J/m^2 . Assuming homogenous nucleation, the minimum undercooling required for nucleation is:

- (1) 158.6 K (2) 172.4 K (3) 167.3 K (4) 163.9 K

75. A cold worked metal recrystallizes completely in 100 hours at 260°C , while it takes only 6 min. for complete recrystallization at 300°C . The activation energy (kJ/mol.K) for recrystallization is:

- (1) 4.9×10^5 (2) 4.4×10^5 (3) 4.0×10^5 (4) 3.6×10^5

ELECTRICAL ENGINEERING

76. A 200 V, 10A, 190 rad/s separately excited dc motor is having an armature resistance of 1Ω . The motor is coupled to a load whose torque speed relationship is given by $T_L = 0.03\omega$ wherein the load torque, T_L is expressed in Nm and the speed, ω is expressed in rad/s. Neglecting friction and other rotational losses, the steady state speed at which the motor drives the load, while rated voltages are applied to the armature and field terminals of the dc motor is

- (1) $\frac{190}{1.03} \text{ rad/s}$ (2) $\frac{200}{1.03} \text{ rad/s}$ (3) $\frac{210}{2.03} \text{ rad/s}$ (4) $\frac{190}{2.03} \text{ rad/s}$

77. A single phase fully controlled thyristorised ac to dc converter connected to a 230 V, 50 Hz single phase sinusoidal ac supply is feeding a purely resistive load of magnitude 10Ω as shown in the figure. When the converter is operated with a firing angle, α equal to 60° , and the circuit has attained steady state, the average of the voltage, v_0 impressed across the load is

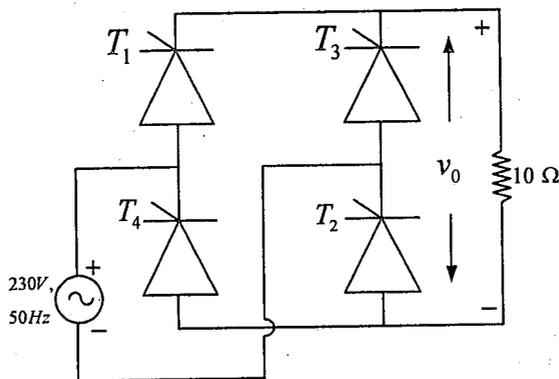

- (1) $\frac{690}{\pi\sqrt{2}}$ (2) $\frac{230\sqrt{2}}{\pi}$ (3) $\frac{345}{\pi}$ (4) $\frac{230}{\pi}$

78. When the input voltage applied to a certain dc to dc converter (figure A) is 100 V, the output voltage of the converter is found to be 50V while the converter is operating at steady state under continuous mode of conduction with a certain duty cycle, δ . The approximate waveform of the input current, i of the converter is shown in Figure B. The dc to dc converter is a

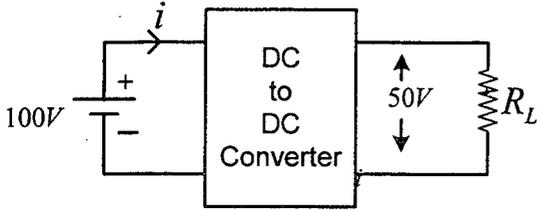

Figure A

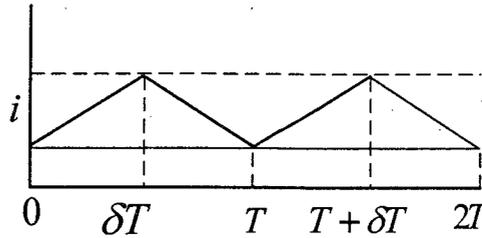
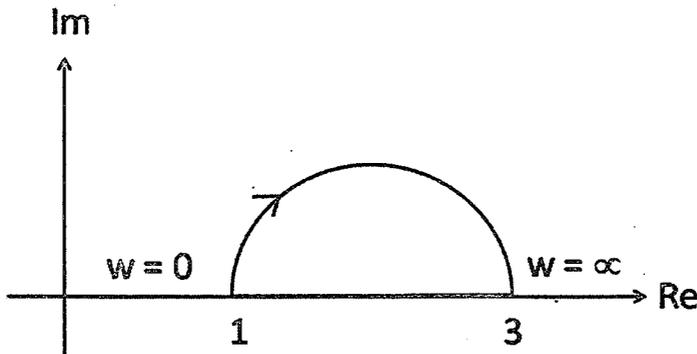

Figure B

- (1) Boost Converter
 (2) C'uk Converter
 (3) Buck Converter
 (4) Buck Boost Converter
79. A 400 V, 3- ϕ , 50 Hz, 950 rpm squirrel cage induction motor is having per phase rotor resistance, referred to the stator, $r_2' = 0.5 \Omega$. The per phase standstill rotor reactance, series stator impedance and the effect of the magnetizing branch of the machine can be neglected. The machine is fed from a voltage source inverter and is operated as a V/f controlled drive. The motor is running at a steady state speed of 375 rpm while driving half of its rated torque. Assuming the output voltage of the inverter to be purely sinusoidal, the frequency and rms value of the line to line inverter output voltage are respectively
- (1) 20 Hz 160 V
 (2) 18.75 Hz 150 V
 (3) 21.25 Hz 170 V
 (4) 18.75Hz 400 V

80. The Nyquist plot of a compensator is shown in the figure. The compensator is a



- (1) lead compensator with maximum phase lead of 19.5°
 (2) lag compensator with maximum phase lag of 19.5°
 (3) lead compensator with maximum phase lead of 30°
 (4) lag compensator with maximum phase lag lead of 30°

81. Given the open loop transfer function $\frac{15}{s(s+3)(s^2+2s+2)}$, the angle of departure of the root loci from the complex poles are

- (1) -63.43° and 63.43° (2) -67.49° and 67.49°
 (3) -71.57° and 71.57° (4) -75.62° and 75.62°

82. An alternator represented by a voltage of constant magnitude ($E' = 1.0818$ p.u.) behind the transient reactance ($x'_d = 0.05$ p.u.) is supplying an active power of 1.0 p.u. to an infinite bus through a connecting line represented by a lumped reactance, $x_l = 0.32$ p.u.. The magnitude of the infinite bus voltage is 1.0 p.u. and its angle is 0° . The system frequency is 60 Hz. The inertia constant of the alternator, $H = 5$ s and the damping coefficient is $k_D = 0$. A fault takes place in the connecting line near the generator terminal as shown in the figure and it is cleared after 0.2 s. As a result, the generator rotor angle (δ) starts oscillating between 87.12° and

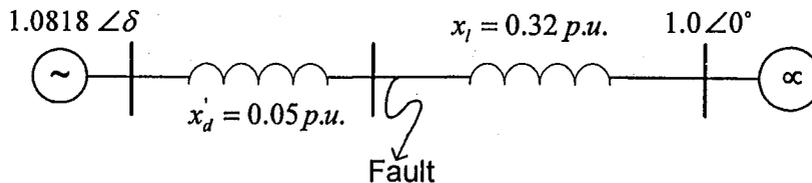

- (1) 20° (2) 0° (3) -67.12° (4) -37.45°

83. Two 300 MVA, 22 kV, 3-phase, 60 Hz alternators are connected by a transmission line having transformers at both ends as shown in the single line diagram given below.

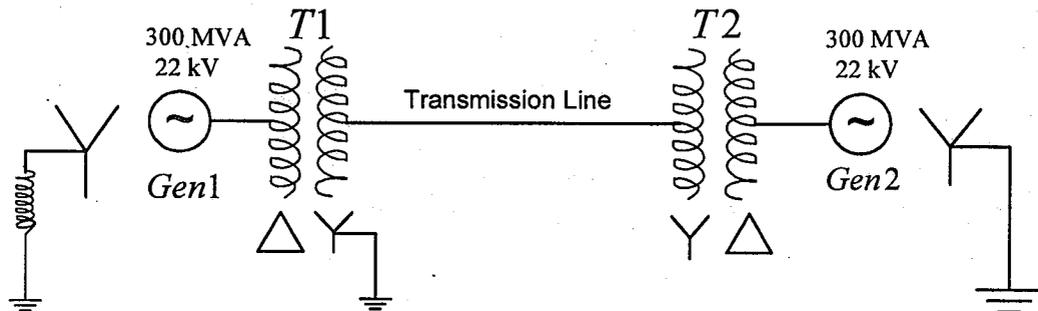

The transformer (T1) between the generator 1 and the transmission line is a Δ -Y connected 3-phase transformer bank made up of three single phase transformers each rated at 120 MVA, 22kV/127kV with leakage reactance of 8%. The generator 2 is connected to the line by a 3-phase, 300MVA, 22kV/220kV, Δ -Y transformer (T2) with 10% leakage reactance. The star side of T1 is grounded whereas that of T2 is ungrounded. The zero sequence reactance of the transmission line is 81Ω . Considering the MVA rating of T1 as the base, the zero-sequence network of the complete system is as shown in

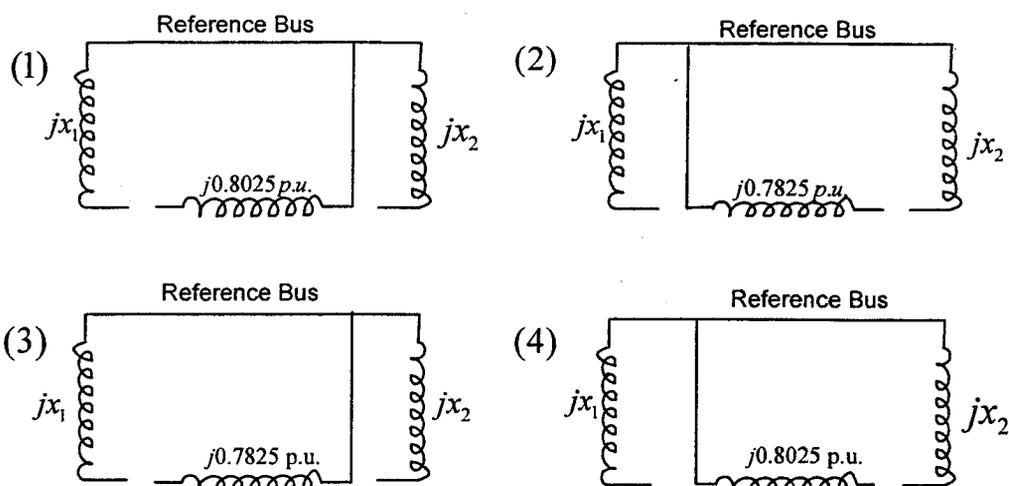

84. The single line diagram of a power system network having 3 buses and 4 lines is shown in the figure below. The line data is provided in the associated table. The values of the (2, 2) and (2, 1) elements of the bus admittance matrix (Y_{BUS}) are

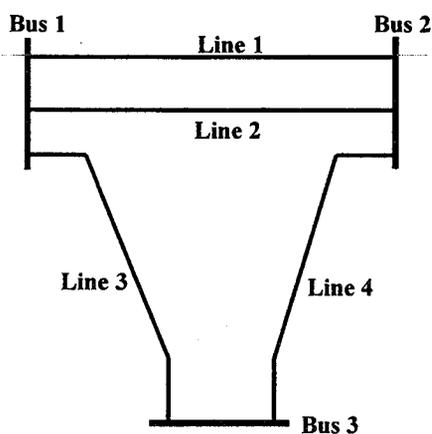

Line No	From bus	To bus	Series Impedance		Line Charging susceptance, B (p.u.)
			R (p.u.)	X (p.u.)	
1	1	2	0.01	0.10	1.20
2	1	2	0.01	0.08	1.00
3	1	3	0.01	0.08	1.00
4	2	3	0.02	0.14	1.50

- (1) $Y_{BUS}(2,2) = -3.5286 + j27.4087$; $Y_{BUS}(2,1) = -2.5286 + j22.2087$;
 (2) $Y_{BUS}(2,2) = -3.5286 + j27.4087$; $Y_{BUS}(2,1) = 2.5286 - j22.2087$;
 (3) $Y_{BUS}(2,2) = 3.5286 - j27.4087$; $Y_{BUS}(2,1) = -2.5286 + j22.2087$;
 (4) $Y_{BUS}(2,2) = 3.5286 - j27.4087$; $Y_{BUS}(2,1) = 2.5286 - j22.2087$;

85. For the circuit shown in the associated figure, the switch 'K' was closed at time $t = -\infty$ and the circuit reached steady state. The voltage source and the current source are ideal. The earliest instant t_1 ($t_1 > 0$) at which the switch can be opened without giving rise to any transient in the inductor current is

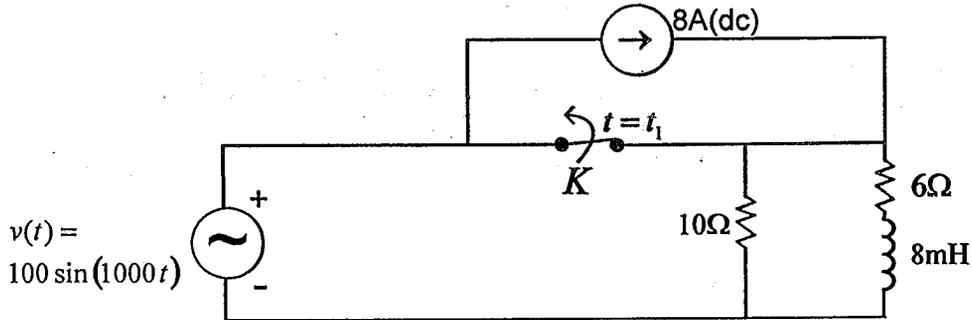

- (1) 3.25s (2) 1.45s (3) 3.25ms (4) 1.45ms

FLUID MECHANICS

86. Smoke is released from a tall chimney from ABC industry. Wind blows from north to south upto time T and thereafter, the direction changes from east to west. After time T , streaklines for smoke particles coming out of the chimney are oriented as



87. A flat plate is exposed to a steady, constant density fluid flow with a free stream parallel to the axis of the plate (case 1). In another case, this plate is replaced by a plate which is half the length of the previous plate (case 2), all other conditions remaining unaltered. In both the cases, flow over the entire length of the plate is laminar. What is the ratio of the drag coefficients for these two cases (Given: the local boundary layer thickness δ scales as $\frac{\delta}{x} \sim Re_x^{-1/2}$, where Re_x is the local Reynolds number at an axial coordinate x)?

- (1) $\frac{C_{D,1}}{C_{D,2}} = 0.500$ (2) $\frac{C_{D,1}}{C_{D,2}} = 0.666$ (3) $\frac{C_{D,1}}{C_{D,2}} = 0.707$ (4) $\frac{C_{D,1}}{C_{D,2}} = 1.000$

88. Consider steady, fully developed, laminar flow of oil with density ρ and viscosity μ between two horizontal parallel plates at a distance H apart. The lower plate moves to the left (negative x -direction) with a uniform speed U , while the upper one is kept stationary. A constant pressure gradient of $\frac{dp}{dx}$ drives the flow in such a way that the net flow rate across any section is zero. The pressure gradient is given by

- (1) $\frac{dp}{dx} = \frac{6\mu U}{H^2}$ (2) $\frac{dp}{dx} = -\frac{6\mu U}{H^2}$
 (3) $\frac{dp}{dx} = \frac{2\mu U}{H^2}$ (4) $\frac{dp}{dx} = -\frac{2\mu U}{H^2}$

89. A pipeline carrying oil of density 850 kg/m^3 has the following geometric and flow data at two different sections A and B.

Section	Diameter (cm)	Pressure (kN/m^2)	Height from ground level (m)
A	80	180	10
B	50	100	13

If the average velocity at Section A is 5 m/s , what is the direction of flow?

- (1) from A to B
 (2) from B to A
 (3) no net flow
 (4) cannot predict from the above data
90. An engine oil, SAE – 10 at 20°C flows through two different pipes as follows:

Pipe	Flow rate (m^3/s)	Diameter (m)	Relative roughness
1	0.02	0.3	0.001
2	0.01	0.2	0.002

If the kinematic viscosity of SAE–10 at 20°C is $1 \times 10^{-4} \text{ m}^2/\text{s}$, then

- (1) flow through pipe 1 has a lower friction factor compared to flow through pipe 2
 (2) flow through pipe 1 has a higher friction factor compared to flow through pipe 2
 (3) flows through both pipe 1 and pipe 2 have the same friction factor
 (4) no comparison is possible because of inadequate data
91. A rectangular heated electronic chip floats on the top of a thin layer of air of thickness h , above a perforated bottom plate as shown in the figure. Air is blown at a uniform velocity v_0 through holes of the bottom plate. For steady, inviscid, constant density flow, the acceleration field is given by (assuming that the x -component of velocity does not vary with y).

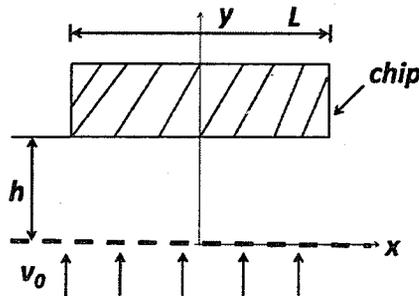

- (1) $\vec{a} = \frac{v_0^2 x}{h^2} \hat{i} - \frac{v_0^2}{h} \left(1 - \frac{y}{h}\right) \hat{j}$
 (2) $\vec{a} = \frac{v_0^2 x}{h^2} \hat{i} + \frac{v_0^2 y}{h^2} \hat{j}$
 (3) $\vec{a} = \frac{v_0^2 x}{h^2} \left(1 - \frac{x}{L}\right) \hat{i} - \frac{v_0^2}{h} \left(1 - \frac{y}{h}\right) \hat{j}$
 (4) $\vec{a} = \frac{v_0^2}{h} \left(1 - \frac{x}{L}\right) \hat{i} + \frac{v_0^2 y}{h^2} \hat{j}$

92. A fluid of constant density ρ flows steadily past a porous plate with a uniform free stream velocity u_∞ as shown in the figure. Fluid is sucked through the porous section with a velocity of $0.1 u_\infty$. Velocity distribution at section CD is given by $\frac{u}{u_\infty} = \frac{3}{2} \left(\frac{y}{\delta}\right) - \frac{1}{2} \left(\frac{y}{\delta}\right)^3$. Mass flow rate per unit width of the plate, perpendicular to the plane of the figure across the section BC is

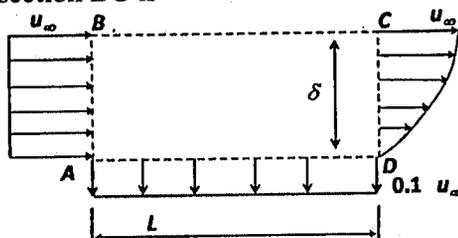

(Figure not to scale)

- (1) $\rho u_\infty \frac{3\delta}{8}$ (2) $\rho u_\infty \left(\frac{3\delta}{8} + 0.1L\right)$
 (3) $\rho u_\infty \left(\frac{3\delta}{2} - 0.1L\right)$ (4) $\rho u_\infty \left(\frac{3\delta}{8} - 0.1L\right)$

93. A three dimensional velocity field is given by

$$\begin{aligned} u(x,y,z) &= Ax + 2By + C \\ v(x,y,z) &= Ay + D \\ w(x,y,z) &= -2Az + E \end{aligned}$$

Where A,B, C, D, E are constants. The rate of volumetric strain ($\dot{\epsilon}$) and the vorticity ($\vec{\Omega}$) are given by (where \hat{k} is the unit vector along z direction)

- (1) $\dot{\epsilon} = 0, \quad \vec{\Omega} = B\hat{k}$ (2) $\dot{\epsilon} = A, \quad \vec{\Omega} = B\hat{k}$
 (3) $\dot{\epsilon} = -2A, \quad \vec{\Omega} = -B\hat{k}$ (4) $\dot{\epsilon} = 0, \quad \vec{\Omega} = -2B\hat{k}$

94. For steady, incompressible, inviscid flow past a circular cylinder, the stream function (ψ) and velocity potential (ϕ) are given as follows:

$$\phi = u_\infty \left(r + \frac{R^2}{r} \right) \cos\theta$$

$$\psi = u_\infty \left(r - \frac{R^2}{r} \right) \sin\theta$$

Pressure coefficient on the cylinder surface as a function of θ , is given as,

- (1) $1 - (\sin\theta)^2$ (2) $1 - (\sin 2\theta)^2$ (3) $1 - (2\sin\theta)^2$ (4) $1 - (2\sin 2\theta)^2$

95. Water strikes from a two dimensional nozzle in steady motion with a velocity of 60 m/s against a guide vane moving with a velocity 20 m/s. If density of water is 1000 kg/m^3 and jet has a cross sectional area of 0.15 m^2 , the magnitude of the force acting on the vane is

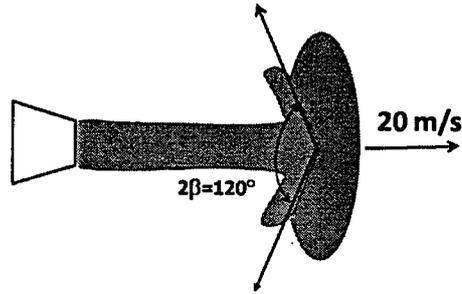

- (1) 160 kN (2) 260 kN (3) 360 kN (4) 460 kN

SOLID MECHANICS

96. Two bars of length l are joined together to form a structural system that is fixed at top and bottom as shown. The bottom part BC of the structure has a cross-sectional area twice that of the top part AB . Both the bars are made of the same elastic material. What is the maximum stress in the top part AB of this structural system if a load P acts at B as shown. Neglect the self weight of the system.

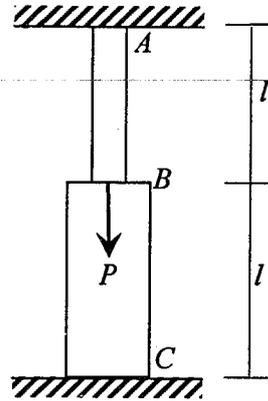

- (1) $\frac{2P}{A}$ (2) $\frac{P}{A}$ (3) $\frac{P}{2A}$ (4) $\frac{P}{3A}$

97. A thin solid circular shaft of diameter D and of total length $3L$ is held fixed at one end and load by a torques T_1 at B and T_2 at C as shown. Determine the twist in the shaft at C . The modulus of rigidity is given by G .

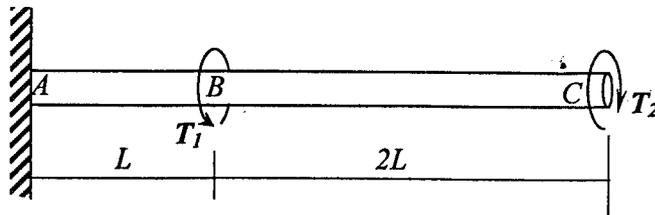

- (1) $\frac{32(3T_2+T_1)L}{\pi GD^4}$ (2) $\frac{32(3T_2-T_1)L}{\pi GD^4}$ (3) $\frac{64(2T_2+T_1)L}{\pi GD^4}$ (4) $\frac{64(2T_2-T_1)L}{\pi GD^4}$

98. A three-bar structure made of bars pinned to each other at G and at the supports B, C and D is subjected to a load P as shown. All the bars have the same cross-section, A and elastic modulus, E . Compute the deflection of joint G due to the applied load. ($\theta=60^\circ$)

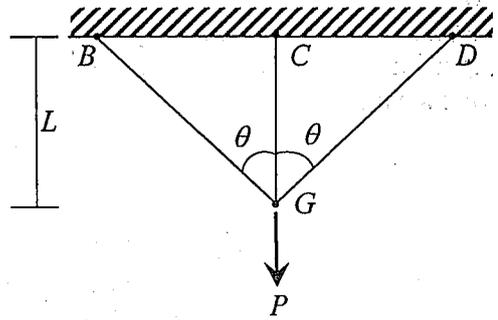

- (1) $\frac{PL}{3AE}$ (2) $\frac{PL}{2AE}$ (3) $\frac{4PL}{3AE}$ (4) $\frac{4PL}{5AE}$

99. A rigid rod of length L and weight W rests on a small roller at B and leans against a vertical wall at A as shown. Assume the surface of the wall is smooth. Find the length of the rod that is in equilibrium for the given configuration in terms of a and θ .

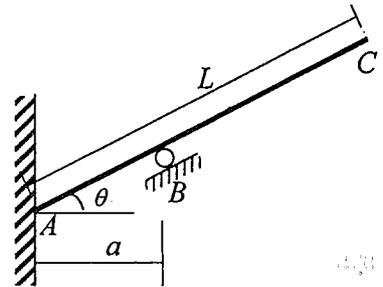

- (1) $L = 4 \frac{a}{\cos \theta}$ (2) $L = 2 \frac{a}{\cos^3 \theta}$ (3) $L = \frac{a}{\cos^2 \theta}$ (4) $L = \frac{a}{2 \cos \theta}$

100. A cantilever beam of length L with a square bend at the end as shown is loaded with a force P . Find the maximum flexural stress in the beam at B (see figure). The cross section of the beam is rectangular with breadth, b and height, h .

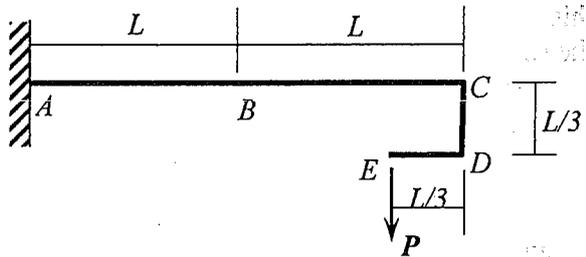

- (1) $\sigma_{max} = \frac{16PL}{bh^2}$ (2) $\sigma_{max} = \frac{8PL}{bh^2}$ (3) $\sigma_{max} = \frac{4PL}{bh^2}$ (4) $\sigma_{max} = \frac{2PL}{bh^2}$

101. A circle of diameter a mm is scribed on an unstressed aluminium plate of thickness $t=0.1a$ mm. Forces acting in the plane of the plate later cause normal stresses $\sigma_{xx} = \sigma$ and $\sigma_{zz} = 2\sigma$. The elastic modulus is E Gpa and Poisson's ratio is 0.25. Determine the change in principal diameters ΔAB and ΔCD of the original circle.

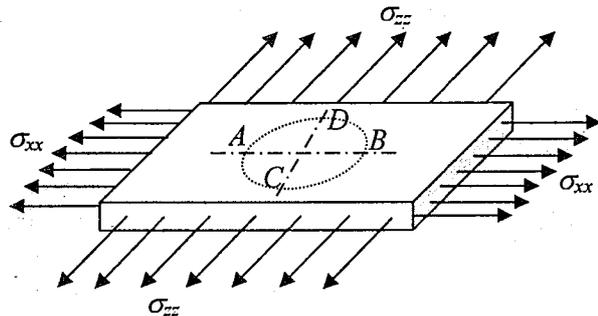

- (1) $\Delta AB = \frac{0.5a\sigma}{E}$; $\Delta CD = \frac{1.75a\sigma}{E}$ (2) $\Delta AB = \frac{-0.5a\sigma}{E}$; $\Delta CD = \frac{1.75a\sigma}{E}$
 (3) $\Delta AB = \frac{-0.5a\sigma}{E}$; $\Delta CD = \frac{-1.75a\sigma}{E}$ (4) $\Delta AB = \frac{0.5a\sigma}{E}$; $\Delta CD = \frac{-1.75a\sigma}{E}$

102. A steel shaft and an aluminium tube are connected to fixed support at one end and to a rigid disk at the other end as shown. Determine the maximum allowable torque that can be applied to the disk if the allowable shear stresses are τ in the steel shaft and 0.75τ in the aluminium tube. Use G for rigidity modulus for steel and $0.5G$ for aluminium.

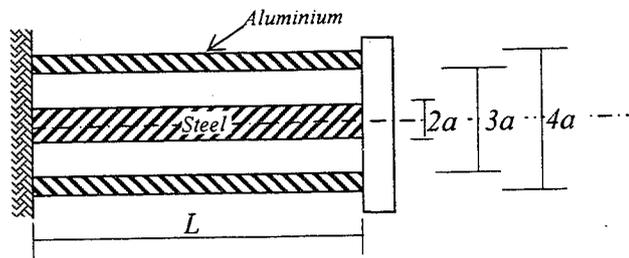

- (1) $6.5\pi\tau a^3$ (2) $7.5\pi\tau a^3$ (3) $11.5\pi\tau a^3$ (4) $23\pi\tau a^3$
103. At a point in a body in plane stress, is subjected to two different conditions (a) an equibiaxial stress, $\sigma_{xx} = \sigma_{yy} = \sigma$ (b) a pure shear stress $\tau_{xy} = \sigma$. Find the magnitude of the maximum principal stress in each of these cases.

- (1) $\sigma_{\max} = \sigma$; $\sigma_{\min} = 0$; (2) $\sigma_{\max} = 0$; $\sigma_{\min} = \sigma$;
 (3) $\sigma_{\max} = \sigma$; $\sigma_{\min} = \sigma$; (4) $\sigma_{\max} = 0$; $\sigma_{\min} = 0$;

104. Find the natural frequency of an inverted pendulum with mass m attached at the tip (as shown in the figure). The length of the rod is L . Assume the rod to be rigid and massless. The rod is pinned at the bottom. Assume small amplitude of oscillation.

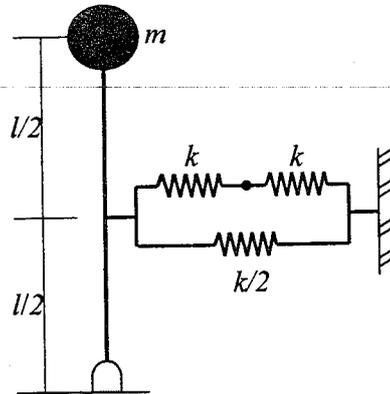

- (1) $\omega = \sqrt{\left(\frac{k}{2m} + \frac{g}{l}\right)}$ (2) $\omega = \sqrt{\left(\frac{2k}{m} + \frac{g}{l}\right)}$
 (3) $\omega = \sqrt{\left(\frac{2k}{m} - \frac{g}{l}\right)}$ (4) $\omega = \sqrt{\left(\frac{k}{2m} - \frac{g}{l}\right)}$

105. A cantilever rod of length L , area of circular cross section A and moment of inertia I , is subjected to temperature change. The rod has a space δ for free expansion after which the free end gets locked and fixed into the wall at B . Find the expression for increase in temperature (ΔT) at which the elastic instability first occurs. Assume E to be constant with temperature change and α as the coefficient of linear expansion.

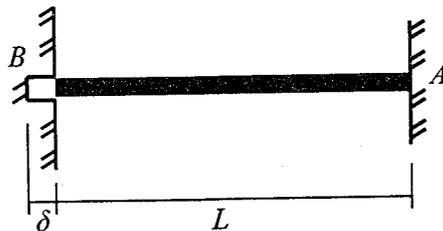

- (1) $\Delta T = \frac{1}{L\alpha} \left(\delta + \frac{4\pi^2 I}{AL(1+\delta/L)^2} \right)$ (2) $\Delta T = \frac{1}{L\alpha} \left(\delta + \frac{\pi^2 I}{AL(1+\delta/L)^2} \right)$
 (3) $\Delta T = \frac{1}{L\alpha} \left(\delta + \frac{\pi^2 I}{4AL} \right)$ (4) $\Delta T = \frac{1}{L^2\alpha} \left(\delta + \frac{4\pi^2 I}{AL} \right)$

COMPUTER SCIENCE

106. The recurrence relation

$$f_n = f_{n-1} + f_{n-2}, f_1 = f_2 = 1$$

Defines the Fibonacci Sequence. Which of the following is FALSE?

- (1) $f_n \leq \left(\frac{5}{3}\right)^n$ for all $n \geq 1$.
 (2) $f_{n+1}^2 - f_n^2 = f_{n-1} \cdot f_{n+2}, n > 2$.
 (3) $f_n = \frac{1}{\sqrt{5}} \left[\left(\frac{1+\sqrt{5}}{2}\right)^n + \left(\frac{1-\sqrt{5}}{2}\right)^n \right], n \geq 1$.
 (4) $f_{n+2} = 1 + f_1 + f_2 + \dots + f_n$, for all $n \geq 1$.
107. Let A [1..15] be an array of integers storing a heap of integers starting from A[1]. A heap with eight values in A is shown in Fig.(a). Suppose we perform the heap operations Insert (45), Insert (27), Insert (10) and followed by Deletemin in that order in the heap stored in A. The values in (A[5], A[1], A[10]) are

A	21	28	32	40	35	39	50	60							
	1	2	3	4	5	6	7	8	9	10	11	12	13	14	15

- (1) (28, 21, 35) (2) (35, 10, 21) (3) (21, 28, 35) (4) (35, 21, 27)
108. In a dynamic programming formulation, the following recurrence is obtained.

For $0 \leq i \leq j \leq 3$,

$$m_{ij} = \min_k \{m_{ik} + m_{k+1,j} + d_i d_{k+1} d_{j+1}\}$$

For $0 \leq i \leq k < j \leq 3$,

Where $m_{ii} = 0$ for $0 \leq i \leq 3$.

If $(d_0, d_1, d_2, d_3, d_4) = (20, 10, 50, 5, 30)$ respectively, the value of m_{03} is

- (1) 6000 (2) 6500 (3) 7000 (4) 7500
109. What does the following program print?

```
# include <stdio.h>
int EXP (int a, int b);
int main (void)
{ int x = 3;
  int y = 5;
  printf ("%d\n", EXP (x, y));
  return 0
}
int EXP (int a, int b)
{ if (b == 1) {return a;}
  Else {return a + EXP (a, b - 1);}
}
```

- (1) 243 (2) 125 (3) 8 (4) 15

110. Consider the following binary tree

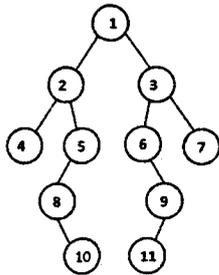

Which of the following is true?

- (1) PREORDER SEQUENCE – 1 2 4 5 8 10 3 6 9 11 7
 POSTORDER SEQUENCE – 4 10 8 5 2 11 9 6 7 3 1
- (2) PREORDER SEQUENCE – 1 2 4 5 8 10 6 3 9 7 11
 POSTORDER SEQUENCE – 4 10 8 5 11 2 9 6 7 3 1
- (3) PREORDER SEQUENCE – 1 2 4 5 8 10 6 3 9 11 7
 INORDER SEQUENCE – 1 2 3 4 5 6 7 8 9 10 11
- (4) INORDER SEQUENCE – 1 2 4 5 8 10 3 6 9 11 7
 POSTORDER SEQUENCE – 11 10 9 8 7 6 5 4 3 2 1
111. A 10-bit synchronous binary counter C1 is driven by an external 10 KHz clock. The most significant bit of C1 is connected to the clock input of another 8-bit binary counter C2. Both C1 and C2 are initialized to 0. What is the value of C2 if the system operates for 1.5 seconds?
- (1) 8 (2) 10 (3) 14 (4) 15
112. Assume that the memory access time to main memory on a Cache “miss” takes 30 ns and memory access time to the cache on a “hit” takes 3 ns. If 75% of the processors memory requests resulted in a cache hit, what is the average memory access time?
- (1) 9.75 ns (2) 10.5 ns (3) 15 ns (4) 16.5 ns
113. A process contains 8 virtual pages on disk and is assigned a fixed allocation of 4 page frames in main memory. The following page trace occurs:
 1, 0, 2, 1, 6, 7, 0, 1, 2, 0, 3, 2, 4, 2, 5
 Assume that the frames are initially empty. Compute the hit ratio in main memory for the LRU page replacement policy
- (1) $\frac{1}{2}$ (2) $\frac{1}{5}$ (3) $\frac{2}{3}$ (4) $\frac{1}{3}$
114. Consider the following two sets of functional dependencies:
 $F = \{A \rightarrow C, AC \rightarrow D, E \rightarrow AD, E \rightarrow H\}$ and $G = \{A \rightarrow CD, E \rightarrow AH\}$. Which of the following statement is TRUE?
- (1) F covers G but G does not cover F
 (2) G cover F but F does not cover G
 (3) F and G are equivalent
 (4) None of the above can be asserted

115. Consider the following schedule for transactions T_1 , T_2 and T_3 :

T_1	T_2	T_3
Read (X)		
	Read (Y)	
Read (Y)		Read (Y)
	Read (X)	
		Write (Y)
	Write (Z)	
Read (Z)		

Which of the following serial schedule as a correct serialization of the above?

- (1) $T_1 \rightarrow T_3 \rightarrow T_2$ (2) $T_2 \rightarrow T_1 \rightarrow T_3$
(3) $T_2 \rightarrow T_3 \rightarrow T_1$ (4) $T_3 \rightarrow T_1 \rightarrow T_2$