

# EARTH SCIENCES

This Test Booklet will contain 120 (20 Part 'A'+50 Part 'B'+50 Part 'C') Multiple Choice Questions (MCQs). Candidates are required to answer 15 in part 'A', 35 in Part 'B' and 10 questions in Parts 'C' respectively(No. of question to attempt may vary from exam to exam). In case any candidate answers more than 15, 35 and 10 questions in Parts A, B and C respectively only first 15, 35 and 10 questions in Parts A, B and C respectively will be evaluated. Questions in Parts 'A' and 'B' carry two marks each. In Part 'C' each question may have sub-parts and it carry 10 marks each. There will be negative marking @25% for each wrong answers in Part 'A' and 'B', and no Negative marking for Part 'C'. Below each question, four alternatives or responses are given. Only one of these alternatives is the 'CORRECT' answer to the question.

## MODEL QUESTION PAPER

### PART A

May be viewed under heading "General Science"

### PART B

21. Albedo of a surface is defined by the ratio of outgoing to incoming solar radiation. Keeping this in view, which of the following surface will have the highest albedo?
1. Water
  2. Sand
  3. Snow
  4. Forest
22. Geostrophic wind is a balance between the pressure gradient force and the Coriolis force. In non-geostrophic wind, flow will become circulatory because of
1. pressure difference term
  2. momentum term
  3. temperature difference term
  4. shear term

- 23.** In valley-mountain system, cold air is heavier than warm air, and thus flows down hill as a katabatic wind. In the case of an anabatic wind,
1. wind rises vertically in the valley
  2. wind forms updraft and downdraft motion
  3. wind will flow along the slope
  4. wind will have cross mountain flow
- 24.** Cyclones or hurricanes do not develop within about  $5^{\circ}$  N and S of the equator because the
1. pressure gradient is weak
  2. trade winds converge
  3. ocean surface temperature is high
  4. Coriolis force is very weak
- 25.** When statically stable air flows over a hill or ridge, it is set into oscillation. These waves are known as
1. Rossby waves
  2. Kelvin waves
  3. gravity waves
  4. mountain waves
- 26.** A ceaseless movement of wind and ocean currents results in global circulation because of
1. unequal distribution of oceanic and continental mass
  2. radiative forcing due to Sun-Earth interaction
  3. tilt of Earth's axis
  4. revolution / rotation of Earth
- 27.** The organism that can take  $N_2$  directly from sea water is
1. foraminifera
  2. coccolithophore
  3. cyanobacteria
  4. dinoflagellates
- 28.** Which is the major limiting element in marine primary production?
1. sodium
  2. nitrogen
  3. carbon
  4. argon

- 29.** If the sea surface temperature is increased in Antarctic Ocean due to global warming, the dissolved oxygen in its deep water will
1. increase
  2. initially increase and then decrease
  3. decrease
  4. not change
- 30.** Hydrogenous sediment in the oceans is
1. derived from skeletal debris
  2. precipitated by chemical or biochemical reactions
  3. produced by weathering of rocks on land
  4. ejected by volcanoes
- 31.** Sea surface temperature (SST) is an important and variable parameter of oceans. In the Indian Ocean, SST variability has the largest amplitude on the timescale of
1. century
  2. decadal
  3. interannual
  4. seasonal
- 32.** The speed of current in the wind-driven Ekman layer
1. increases with depth
  2. decreases with depth
  3. remains constant
  4. first decreases and then increases
- 33.** Which one of the following is not true in case of the Arabian Sea?
1. seasonal high biological productivity
  2. mid-depth oxygen minimum zone
  3. net annual evaporation
  4. net annual precipitation
- 34.** Silicon limitation in the upper ocean will hamper the growth of
1. coccolithophos
  2. foraminifera
  3. diatam
  4. corals
- 35.** Which one of the following rock suites represents the oceanic lithosphere?

1. turbidite
  2. ophiolite
  3. seismite
  4. granulite
- 36.** Which one of the following is defined by shear strain?
1. change in length
  2. change in angle
  3. change in volume
  4. change in area
- 37.** Which one of the following is a measure of compressibility of a material?
1. elasticity (E) Young's modulus
  2. rigidity (G) shear modulus
  3. Poisson's ratio ( $\gamma$ )
  4. viscosity ( $\eta$ )
- 38.** Four oxygen ions of radius  $r_c$  (incompressible and touching spheres) are located at the corners of a square. What will be the radius ratio  $r_c/r_a$  of the cation (radius:  $r_c$ ) lodged at the centre of the square?
1.  $2\sqrt{2}$
  2.  $\sqrt{2} - 1$
  3.  $(\sqrt{2} - 1)/2$
  4.  $\sqrt{2} + 1$
- 39.** A light beam is incident on a mirror at an angle  $\theta$  with the normal to the mirror. If the mirror is rotated in the direction of incident beam by an angle  $r$ , what will be the rotation angle of the reflected beam with respect to its previous position?
1.  $r$
  2.  $r + \theta$
  3.  $r - \theta$
  4.  $2r$
- 40.** Coesite, a high pressure polymorph of quartz is found in rocks exposed on Earth's surface because, coesite
1. is stable at low temperature
  2. is a high density mineral
  3. is not kinetically favoured for decomposition
  4. has the lowest free energy at the Earth's surface

41. In  $\text{Al}_2\text{SiO}_5$ , the  $\text{Al}_2\text{O}_3$  content (in wt %) is close to
1. 80
  2. 60
  3. 40
  4. 20
42. In the feldspar mineral structure, chemical substitutions such as  $\text{Ca}^{2+} + \text{Al}^{3+} \rightarrow \text{Na}^{+} + \text{Si}^{4+}$  and  $\text{Na}^{+} \rightarrow \text{K}^{+}$  are common. Amongst the feldspar group of minerals, which one should have the highest amount of Al?
1. albite
  2. anorthite
  3. orthoclase
  4. oligoclase
43. Generation of nuclear energy requires availability of minerals containing U and Th. Which one of the following rocks is known to have high concentrations of nuclear minerals?
1. basalt
  2. diorite
  3. granodiorite
  4. pegmatite
44. Which one of the following minerals will have no useful nutrient elements for plant life?
1. plagioclase feldspar
  2. quartz
  3. olivine
  4. biotite
45. The atmosphere of Venus has about 97%  $\text{CO}_2$ . If so, the planet should have
1. an abundance of photosynthesizing bacteria
  2. an abundance of water
  3. no life at all as the surface should be very hot
  4. an abundance of fossil fuel deposits
46. Which one of the following drainage patterns is typically associated with fold mountain belts?
1. parallel
  2. rectangular
  3. trellis
  4. dendritic

47. If the wave front is exactly parallel to the coast, which one of the following will still occur along the coast?
1. beach drift
  2. longshore drift
  3. longshore current
  4. wave refraction
48. A river will braid irrespective of the fact that it is gravel-bed, sand-bed or silt-bed if
1. sediment supply = sediment transport
  2. sediment supply < sediment transport
  3. sediment supply > sediment transport
  4. sediment supply >> sediment transport
49. If  $g_A$ ,  $g_B$ ,  $g_C$  and  $g_D$  are the Earth's normal gravity values at four locations A( $20.0^\circ$ ,  $79.9^\circ$ ), B ( $19.9^\circ$ ,  $80.0^\circ$ ), C ( $20.0^\circ$ ,  $80.1^\circ$ ) and D ( $20.1^\circ$ ,  $80.0^\circ$ ), then
1.  $g_A > g_C$  ;  $g_B = g_D$
  2.  $g_A < g_C$  ;  $g_B = g_D$
  3.  $g_A = g_C$  ;  $g_B > g_D$
  4.  $g_A = g_C$  ;  $g_B < g_D$
50. If R is the ratio of the Earth's gravity field to its magnetic field at the equator, the ratio of these fields at the poles would be approximately
1. R/4
  2. R/2
  3. R
  4. 2R
51. On the geoidal surface, the Earth's gravity field
1. is everywhere zero
  2. is a constant and is normal to the surface
  3. varies along the surface, but is normal to it
  4. varies in magnitude and direction along the surface
52. An isostatically compensated elevated landmass is characterized by
1. strong negative Bouguer and free-air anomalies
  2. strong negative Bouguer and little or no free-air anomalies
  3. strong positive Bouguer and little or no free-air anomalies
  4. strong positive Bouguer and free-air anomalies

- 53.** The remnant magnetism in a rock solidified in the Earth's magnetic field at a latitude of  $30^\circ$ , dips
1. at  $30^\circ$
  2. between  $30^\circ$  and  $45^\circ$
  3. between  $45^\circ$  and  $60^\circ$
  4. at an angle greater than  $60^\circ$
- 54.** The shadow zone is the region bounded by the disappearance of P and S waves, and the onset of P waves
1. reflected at the Earth's surface
  2. refracted through the fluid core
  3. reflected at the mantle-core boundary
  4. refracted through the fluid and solid cores
- 55.** Statement I: Ferromagnetic minerals exhibit properties of paramagnetic minerals beyond Curie temperatures.  
Statement II: Mantle rocks are less magnetic than those of the upper crust.
1. statements I and II are true; I explains II
  2. statements I and II are true, but I does not explain II
  3. statement I is true, but II is false
  4. statement I is false, but II is true
- 56.** An example of intraplate volcanic activity is
1. the Himalaya
  2. island arcs
  3. the Alps
  4. the Hawaiian islands
- 57.** A region with nearly flat topography and large negative gravity anomaly suggests
1. a root in the mantle
  2. thin crust with low density material underplating
  3. thick crust with high density material underplating
  4. thin crust
- 58.** Heat is transported in the lithosphere through
1. advection
  2. radiation
  3. conduction
  4. convection

**59.** If a material of length  $l_0$  changes to  $l$  after homogeneous deformation, then the stretch is

1.  $\frac{l}{l_0}$
2.  $\frac{l-l_0}{l}$
3.  $\frac{l_0}{l}$
4.  $\frac{l}{l-l_0}$

**60.** The third most abundant gas in the Earth's atmosphere next to  $N_2$  and  $O_2$  is

1. water vapor
2. Ar
3.  $CO_2$
4.  $O_3$

**61.** Somali jet during Indian summer monsoon season

1. strengthens
2. weakens
3. remains the same
4. reverses

**62.** In the troposphere, the temperature decreases as a function of height because

1. air is incompressible and its pressure decreases with height
2. air is compressible and its pressure increases with height
3. air is compressible and its pressure decreases with height
4. air is incompressible and its pressure increases with height

**63.** Which one of the following results in a decrease in the kinetic energy of a stream?

1. bed erosion
2. bed deposition
3. bank erosion
4. bank deposition (overbank)

**64.** Which one of the following statements is false?

1. The organisms with hard parts (skeletons) appeared in early Cambrian
2. Devonian is known as the "age of fishes"
3. Graptolites appeared and become extinct during Paleozoic
4. Permian/Triassic boundary mass extinction event was far less devastating than the K-T boundary mass extinction event



- 65.** Which rock type would constitute best aquifer?
1. sandstone
  2. conglomerate
  3. limestone
  4. basalt
- 66.** Which one of the following does not contribute to the mass wasting process in a mountainous region?
1. steep slope
  2. thick vegetation
  3. presence of water
  4. high relief
- 67.** The distribution of plants and animals is largely controlled by climate and geographic barriers, which are largely controlled by
1. atmospheric processes
  2. oceanic processes
  3. tectonic processes
  4. soil forming processes
- 68.** Most clay minerals have negative charge on their surfaces. This has an important role for
1. metal nutrients supply to the plants
  2. phosphate supply to the plants
  3. weatherability of clay minerals
  4. supply of  $H^+$  ions to the plants
- 69.** In a satellite image, the intensity of reflected radiation recorded at 1.35 to 1.45  $\mu m$  wave length is the least because of absorption of
1. insolation by atmospheric  $CO_2$  and  $H_2O$
  2. radiation by water bodies at Earth's surface
  3. radiation by polluted water at Earth's surface
  4. insolation by atmospheric oxygen and ozone
- 70.** Which one of the following wavelengths of visible spectrum penetrates deepest in the oceanic euphotic layer?
1. red light
  2. blue light
  3. yellow light
  4. UV light

## PART C

71. (A) Mass extinctions are geologically sudden events that result in the loss of biodiversity and subsequently the evolution of new lineages and global biogeochemical changes. The KTB (Cretaceous/Tertiary boundary) events record:

1. only the demise of dinosaurs
2. expansion of polar ice-sheets
3. decrease in mean global annual temperature
4. the loss of massive calcite shelled invertebrates

(B) Which one of the following section represents the most complete K-T boundary transitions in India with all critical global K-T boundary markers?

1. Bagh Beds of Central India
2. Um Sohryngkew river section of Meghalaya
3. Subathu formation of Himalaya
4. Umaria marine bed in Central India

(C) Column A has certain terms that are related to those in column B

Column A	Column B
1. Radiolaria	1. Stromatolites
2. Conodonts	2. Benthic zone
3. Homo erectus	3. Subduction zone
4. Nummulites	4. Phosphatic microfossils
5. Acritarchs	5. Organic walled microfossils
6. Cynobacteria	6. Bipedalism

Out of the following which one provides the correct set of matched terms from column A and B

1. (A-1, B-3); (A-2, B-4); (A-3, B-6); (A-4, B-2); (A-5, B-5); (A-6, B-1)
2. (A-1, B-3); (A-2, B-5); (A-3, B-2); (A-4, B-4); (A-5, B-1); (A-6, B-6)
3. (A-1, B-3); (A-2, B-4); (A-3, B-6); (A-4, B-2); (A-5, B-5); (A-6, B-1)
4. (A-1, B-3); (A-2, B-5); (A-3, B-6); (A-4, B-1); (A-5, B-2); (A-5, B-4);

72.

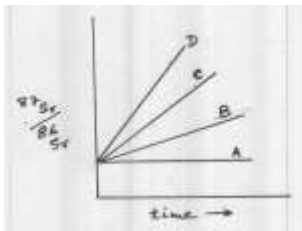

$^{87}\text{Rb}$  decays to  $^{87}\text{Sr}$ , which results in the increase of  $^{87}\text{Sr}$  with time with respect to stable  $^{86}\text{Sr}$ . The above figure shown  $^{87}\text{Sr}/^{86}\text{Sr}$  evolution of 4 samples A, B, C and D with time

- (A) If A, B, C and D represents various rock forming minerals, D is most likely to be
1. olivine
  2. plagioclase
  3. orthoclase
  4. muscovite
- (B) If A, B, C and D represent different earth reservoirs D, is most likely to be the
1. crust
  2. mantle
  3. continental crust
  4. oceanic crust
- (C) Which of the following statements is true?
1. Sample D has the lowest abundance of Rb.
  2. Sample D has the highest Rb/Sr.
  3. Sample A has the highest Rb/Sr.
  4. Sr abundances of  $D > C > B > A$

73. The figure below shows equilibrium crystallization behaviour of a liquid 'P' that cools from initial temperature  $T_1$ , at one atmosphere.

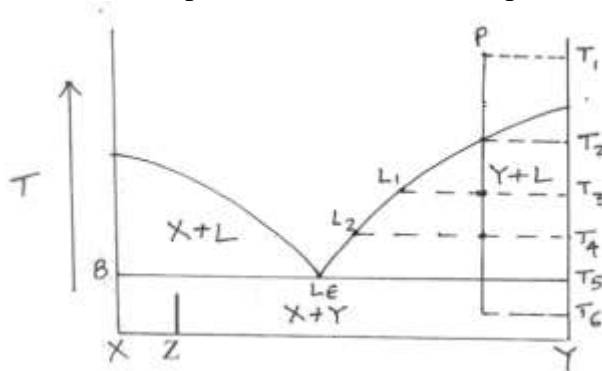

- (A) At temperature  $T_5$ , when the liquid reaches the composition  $L_E$ , which of the following statements is true?
1. Only Y crystallizes.
  2. The system becomes isobaric invariant.
  3. The system becomes isobaric univariant.
  4. The system becomes isobaric bivariant

- (B) If the phase diagram represents equilibrium melting at one atmosphere, then the melt generated at  $T_5$  by a solid of composition 'Z' will have a composition of
1. Z
  2. P
  3.  $L_E$
  4. X
- (C) Assuming that the heat is removed at uniform rate, a temperature-time arrived for equilibrium crystallization of the liquid composition 'P' can be depicted as
1. A
  2. B
  3. C
  4. D

74.

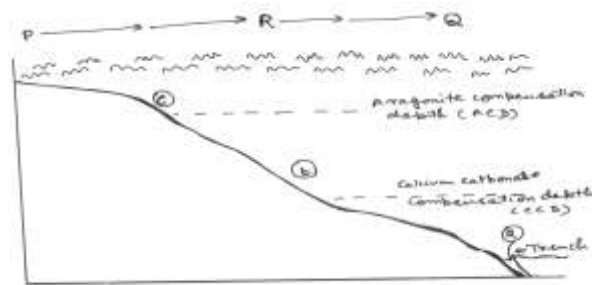

The above diagram shows various depocentres for oceanic sediments, marked with alphabets (a), (b)..... etc. Answer the following.

- (A) Planktic/benthic foraminiferal ratio in oceanic sediments deposited on the floor
1. increases in the direction from P to Q
  2. remains same from P to Q
  3. decreases from P to Q
  4. initially decreases till R and then increases up to Q
- (B) What type of sediments do you expect at (a)?
1. Ptreopod ooze
  2. Forminiferal ooze
  3. Nanno-foram ooze
  4. Siliceous ooze

(C) Which of the following statements is correct?

1. At (c) there will be only radiolarian ooze
2. At (c) there will be a mixture of pteropod ooze, foraminiferal ooze and radiolarian ooze
3. At (b) there will be a mixture of pteropod ooze, foraminiferal ooze and radiolarian ooze
4. At (a) there will be only foraminiferal ooze

**75.** Collision zones are associated with high-P (<10 kbar) to ultra-high (>10 kbar) pressure metamorphism of the subducted crust. A major debate is if the modern day plate tectonics operated in the early Archean vis-a-vis discovering ultra-high P metamorphism in the Archean terrains.

(A) In any mineralogical transformation, the stable assemblage is the one with

1. the highest enthalpy
2. the lowest entropy
3. the highest free energy
4. the lowest free energy

(B) The preservation of ultra-high pressure minerals depends on

1. the local thermodynamic conditions
2. the ability of the minerals to equilibrate during exhumation
3. the availability of water during exhumation
4. the pressure of equilibrium

(C) Polymorphic transformations during cooling-exhumation occur at temperature lower than the thermodynamic P-T conditions because of

1. the lack of energy to drive the reaction due to higher thermal throughput
2. the surplus of energy gained due to cooling
3. lower partial pressure of the ambient fluid
4. ease of reaction progress

**76.** The total free energy change ( $\Delta G_{total}$ ) of a growing hypothetical spherical (radius=r) phase, say in a melt is expressed as

$$\Delta G_{total} = 4\pi r^2(\sigma) + \frac{4}{3}\pi r^3(\Delta G_v) \dots\dots\dots(\text{Eqn. 1})$$

$\Delta G_v$  is the free energy change per unit volume of the phase, and  $\sigma$  is the tensional force normal to surface of the phase.

(A) Since the growth of the phase (increases of  $r$ ) is promoted by minimisation of free energy  $\left(\frac{\partial(\Delta G_{total})}{\partial r}\right)=0$ , the critical radius ( $r_c$ ) of the phase should be

1.  $-2\sigma \Delta G_v$
2.  $-2\frac{\Delta G_v}{\sigma}$
3.  $-\frac{2\sigma}{\Delta G_v}$
4.  $-\frac{2}{\sigma\Delta G_v}$

(B) At the critical radius, the  $\Delta G_{total}$  can be expressed in terms of  $\sigma$  and  $\Delta G_v$  as

1.  $\left(\frac{16\pi}{\sigma^3}\right)(3\Delta G_v^2)$
2.  $\frac{16\pi\sigma^3}{3\Delta G_v^2}$
3.  $\frac{3\pi\sigma^3}{16\Delta G_v^2}$
4.  $(3\pi\sigma^3)(16\Delta G_v^2)$

(C) Based on equation (1) and the results of (A) and (B), identify which one of the following graphs is correct ( $\because \sigma$  is always positive).



1.



2.



3.



4.



77.(A) The essential difference in the formation of gabbro-hosted Ni-sulphide deposits (Ni) and porphyry copper deposits (Cu) is

1. Ni: magmatic segregation Cu: sedimentary exhalation
2. Ni: liquid immiscibility Cu: sedimentary exhalation
3. Ni: liquid immiscibility Cu: magmatic hydrothermal
4. Ni: magmatic segregation Cu: sedimentary exhalation

(B) With decreasing temperature, the observed hydrothermal alteration assemblage in a typical porphyry copper deposit is

1. potassic - phyllic - argillic - propylitic
2. argillic - phyllic - potassic - propylitic
3. phyllic - argillic - potassic - propylitic
4. propylitic - potassic - phyllic - argillic

(C)

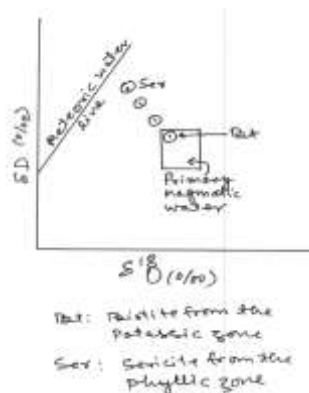

The figure shows disposition of isotopic data in minerals from the alteration zones in a porphyry copper deposit, which can be explained by

1. Temperature decreases
2. Fluid boiling
3. Fluid mixing
4. Fluid unmixing

78.(A) Considering that the sedimentary basins are formed by complex interplay between crustal rigidity, geothermal gradient, isostasy and sediment infilling, identify the correct matching from the sets given below:

(A) Peripheral foreland basin	1) Accretionary prism
B) Rift basin	2) Strike-slip fault
C) Passive margin basin	3) Thrust loading
D) Pull-apart basin	4) Wedge shaped seismic reflectors
E) Trench basin	5) Reefal limestone shale
	6) Glacial tillities
	7) Laterites

1. A-4, B-5, C-3, D-1, E-7
2. A-2, B-1, C-4, D-6, E-3
3. A-3, B-4, C-5, D-2, E-1
4. A-7, B-6, C-3, D-5, E-2

B) The following conditions are given for rock undergoing weathering in different climates.

Case 1. Granite is exposed in arid and humid climatic regions

Case 2. Granite and gabbro are exposed in humid climatic region

Case 3. Granite exposed in humid, and gabbro exposed in arid climatic region

Case 4. Granite and gabbro exposed in arid climatic region

Which of the following statement is not correct?

1. Granite in Case 1 will weather to different extents.
2. Rock in Case 3 will weather to similar extent.
3. Rocks in Case 2 will weather to similar extent.
4. Granite in Case 3 will weather to greater extent compared to gabbro

C) A magma with entrained plagioclase crystals is flowing under simple shear deformation. Which one of the figures shown below is correct, assuming free rotation of plagioclase crystals in the flowing magma?

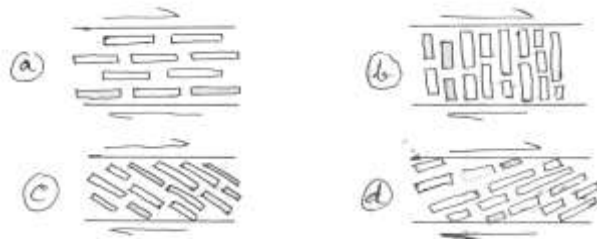



1. a
2. b
3. c
4. d

79. The given geological map represents a folded and faulted terrain. Answer the following:

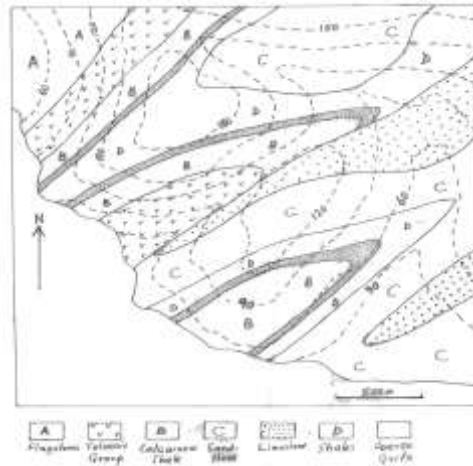

- (A) The dips of the two limbs of folds are
1. both limbs dip in the same direction with same dip
  2. both limbs dip in the same directions, one dips at about  $20^\circ$  and the other at  $60^\circ$
  3. two limbs dip in opposite directions but with same dip
  4. one limb is vertical and the other limb has moderate dip ( $\sim 30^\circ$ )
- (B) Axial trace is defined as trace of axial surface on the ground surface. How many axial traces are present on the map.
1. 2
  2. 3
  3. 4
  4. 5
- (C) Assuming no stratigraphic inversion, the oldest and youngest rocks in this area are
1. oldest: flagstone; youngest: coarse grit
  2. oldest: coarse grit; youngest: flagstone
  3. oldest: sandstone; youngest: calcareous shale
  4. oldest: volcanic group; youngest: sandstone

80.

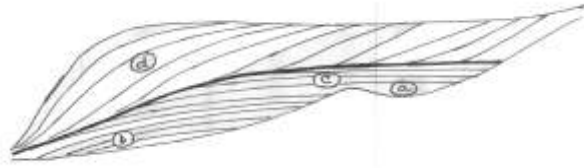

The figure above depicts a clastic marine sedimentary sequence with various system tracts and surfaces. The sequence has been drilled at a several places and core samples collected. Answer the following?

- (A) The thick solid line within the sequence is known as
1. Transgressive surface
  2. Sequence boundary
  3. Maximum flooding surface
  4. Regressive surface of erosion
- (B) The sediments at depth (b) are commonly represented by
1. Evaporites
  2. Mass flows and turbidites
  3. Oolitic Limestone
  4. Phosphorites
- (C) The sediments near depth (c) typically show
1. Coarsening up cycles
  2. Fining up cycles
  3. Invariant grain size
  4. Hiatus
81. (A) If there is an embayment along the coastline experiencing longshore current, the following combinations of features may ultimately result
1. Spit, baymouth bar, lagoon
  2. Spit, lagoon, wave-cut platform
  3. Tombolo, wave-cut platform, arches
  4. Spits, pillars, arches, stacks
- (B) The stacks and arches are formed due to erosion of headland projecting into the sea under the influence of waves. The waves in such conditions are directed on all sides
1. At right angle, towards the headland
  2. At an angle other than right angle, towards the headland
  3. Parallel to the headland, towards it
  4. Away from the headland

(C) Suppose the wave front approaches at an angle to the shoreline and the resulting drift is from north to south. What will happen towards the south of a groin built on the beach?

1. The shore line will accrete
2. The shore line will erode
3. The shore line will neither erode nor accrete
4. Both erosion and accretion will occur

82. (A) Match the following

- |  |                           |
|--|---------------------------|
| a] The amount of water vapour in the atmosphere is very low                      | 1) cyclone                |
| b] Derives its energy from the latent heat released where water vapour condenses | 2) Monsoon                |
| c] Condensation of water vapour  | 3) Aerosols               |
| d] Frozen rain   | 4) Jet streams            |
|  | 5) Greenland & Antarctica |
|  | 6) Thunderstorm           |
|  | 7) Hail                   |
|  | 8) Sleet                  |
|  | 9) Hot deserts            |

1. A-9, B-6, C-8, D-3
2. A-9, B-6, C-3, D-3, B-4
3. A-5, A-9, B-1, B-6, C-3, D-8
4. A-5, B-2, C-3, D-8

(B) Clouds and rain are unlikely to occur in descending air because it

1. cools and increases its capacity to hold moisture
2. cools and reduces its capacity to hold moisture
3. warms and reduces its capacity to hold moisture
4. warms and increases its capacity to hold moisture

(C) Read the following statements and choose the correct answer.

- a) Hurricanes are similar to tornadoes in their mode of formation except the scale is bigger
- b) In the southern hemisphere hurricane frequency is high in August
- c) The frequency of hurricanes is high in northern Indian Ocean
- d) There are no hurricanes along the west coast of South America

1. A-True, B-False, C-False, D-True
2. A-True, B-True, C-False, D-True
3. A- False, B-True, C-False, D-False
4. A- True, B-True, C-True, D-True

(A)

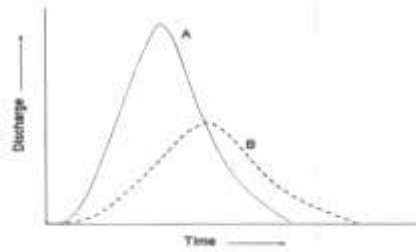

The above diagram gives two hydrographs. Read the graphs and the statements below carefully and choose the correct option.

- A) Curve A shows greater runoff rate
- B) Curve B shows greater runoff rate
- C) Curve A shows greater amount of runoff
- D) Curve B shows greater amount of runoff

- 1) A and B are true
- 2) A and C are true
- 3) A and D are true
- 4) B and D are true

(B) The greater increase in runoff rate and amount in this case could be attributed to

- 1) Narrowing of channel
- 2) Construction of bridges
- 3) Increase in paved areas and storm sewers
- 4) Increased in forest area in the catchment

(C) Choose the correct statement: Curve A represents a drainage basin with

- 1) forest
- 2) forest and grassland
- 3) Grassland
- 4) Grazed grassland

84. (A) Loamy soil constitutes a good agricultural soil. This is largely because loam

- 1) has much higher nutrient bearing clay
- 2) has a higher proportion of sand to make it highly arable
- 3) has roughly equal proportions of sand and silt for both aeration and nutrient Availability
- 4) is rich in silt which holds the soil moisture for a long time.

(B) Match the following

- |                              |                |                               |
|------------------------------|----------------|-------------------------------|
| 1. Zone of leaching          | 5. 'O' horizon | 10. Addition of carbon        |
| 2. Zone of accumulation      | 6. 'C' horizon | 11. Least chemical alteration |
| 3. Humus                     | 7. 'B' horizon | 12. Loss of Ca, Mg, Na        |
| 4. Weathered parent material | 8. 'A' horizon | 13. Fe, Mn enrichment         |

1. 1-8-13, 2-7-12, 3-5-10, 4-6-11
2. 1-5-10, 2-6-11, 3-7-12, 4-8-13
3. 1-8-12, 2-7-13, 3-5-10, 4-6-11
4. 1-7-11, 2-6-13, 3-8-12, 4-5-10

(C) Identify whether true or false and the correct sequence

- A) Alfisols occur in Savanna and drier forest zones
- B) Vertisols are common in rainforest zone and Savanna
- C) Inceptisols are young soils with limited profile development
- D) Soils of Kerala, Meghalaya and Western Ghat are either ultisols or Alfisols

- 1) A-True, B-True, C-False, D-True
- 2) A- False, B-True, C-True, D-False
- 3) A-True, B-False, C-False, D-True
- 4) A-True, B-False, C-True, D-True

85. (A) Match the following

- |                                   |                             |
|-----------------------------------|-----------------------------|
| a. Subsiding air                  | 1) Sahara                   |
| b. Subsiding air and cold current | 2) Basin and range province |
| c. Deep interior of continents    | 3) Kalahari                 |
| d. Rainshadow of mountains        | 4) Tibet                    |
|                                   | 5) Okavango                 |
|                                   | 6) Gobi                     |

1. a-2, b-2, c-5, d-2
2. a-1, b-3, c-6, d-2,
3. a-1, b-2, c-5, d-5
4. a-2, b-3, c-5, d-3

(B) Identify whether true or false and the correct sequence:

- a) Pediment is a broad gently –sloping depositional surface and is formed by the coalescing of individual alluvial fans.
- b) Mushroom rocks can form in rocky deserts because wind erosion by saltating sand is limited to 1 meter above the ground.
- c) The horns of parabolic dunes point downwind and are anchored by vegetation.
- d) Parabolic dunes are the most common dune type in the Thar desert of India.

1. A-False, B-False, C-False, D-False
2. A-True, B-True, C-False, D-True
3. A-True, B-True, C-True, D-True
4. A-False, B-True, C-False, D-True

(C) Match the following

Sand Supply	Dune Type	Special characteristics
1.Limited sand	4.Transverse	8.Product of unidirectional winds
2.Abandant sand	5.Barchans	9.Oriented perpendicular to wind direction
3. Moderate sand	6.Linear	10.Oriented parallel to wind direction
	7.Star	

1. 1-5-8, 2-4-9, 3-6-10
2. 1-6-8, 2-4-9, 3-5-10
3. 1-5-8, 2-4-10, 3-6-9
4. 1-5-9, 2-4-8, 3-6-10

86. (A) Identify whether true or false and the correct sequence:

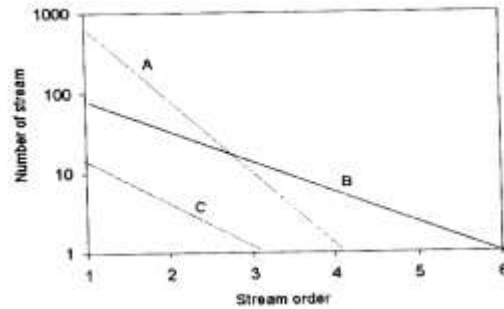

- (A) The bifurcation ratio for the stream C is higher than those of stream B and A
- (B) Stream A drains a plain area
- (C) The drainage density of stream A is higher than those of B and C
- (D) The bifurcation ratio of stream C and B are very similar.

1. A-False, B-False, C-True, D-True
2. A-False B-True, C-True, D-True
3. A-False, B-False, C-True, D-False
4. A-True, B-True, C-False, D-True

(B)

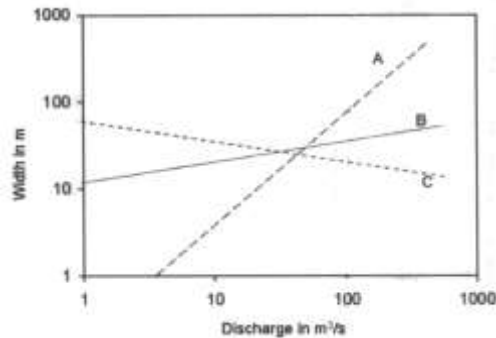

Identify whether true or false and the correct sequence:

- (A) River A is characterized by flash floods.
- (B) River B is very large because its width does not change much with discharge.
- (C) River C does not exist in nature
- (D) River C is characterized by easily erodible banks

1. A-True, B-True, C-True, D-True
2. A-True, B- False C-True, D-False
3. A-True, B-True, C-False, D-False
4. A-False, B-False,C-False, D-False

(C)

Parameter	Stream A	Stream B	Stream C	Stream D
Bifurcation	3.1	4.2	6.7	2.8
Drainage density Km/km <sup>2</sup>	2.0	5.9	3.9	8.2

Which one of the above streams is likely to occur in a tectonically active area?

1. Stream A
2. Stream B
3. Stream C
4. Stream D

87. (A) Typhoons, coastal flooding, tsunamis, earthquakes, volcanic eruptions, landslides and avalanches are most severe in the

1. Circum-Pacific belt
2. Himalayan belt
3. Alpine-Himalayan belt
4. Circum-Pacific and Alpine Himalayan belts

(B) Match the following

Hazard	River
1. Flash flood	6. Brahmaputra
2. Sea water flood	7. Alakananda
3. Bank erosion	8. Kosi
4. Avulsion	9. Satluj
5. Natural dam failure	10. Mahanandi Delta

1. 1-7,2-10,3-6,4-8,5-9
2. 1-6,2-10,3-7,4-9,5-8
3. 1-6,2-10,3-9,4-7,5-8
4. 1-8,2-6, 3-10,4-7, 5-9

(C) Identify whether true or false and the correct sequence:

- (A) Water –saturated sand is less cohesive than damp sand.
- (B) The angle of repose of fine sand is higher than that of coarse sand.
- (C) If the surface material is unconsolidated, heavy rainfall induces earth flows and debris Flows.
- (D) Rock avalanches differ from the rock slides by their much greater velocities and travel distance.

1. A-True, B-False, C-True, D- False
2. A-True, B- False C-True, D-True
3. A-False, B-False,C-True, D-True
4. A-False, B-True, C-True, D-False

88. (A) On a False Colour Composite (FCC) image, bright red, black, grey and sky blue colours generally represent, respectively,

1. Vegetation, settlements, lakes and rivers
2. Vegetation, deep water and shadows, settlements and dry lakes
3. Vegetation, deep water and shadows, settlements and shallow water
4. Vegetation, shadows, settlements and shallow water

(B) Statements given below pertain to electromagnetic radiation. Identify whether true or false and the correct sequence:

1. Higher the wavelength, higher the frequency
2. Lower the frequency, higher the energy
3. Higher the wavelength, lower the energy
4. Higher the frequency, lower the energy
5. Higher the frequency, higher the energy

1. 1-True; 2-False; 3-True; 4-False; 5-True
2. 1-False; 2-True; 3-False; 4-False; 5-False
3. 1-False; 2-False; 3-False; 4-True; 5-True
4. 1-False; 2-False; 3-True; 4-False; 5-True

(C) Match the following

1. Active Remote Sensing	(a) Sun temperature
2. 8-14 $\mu$ m	(b) CARTOSAT
3. Temporal resolution	(c) Visible Region
4. 6000°K	(d) RBV
5. Stereo image	(e) RADAR
	(f) Microwave Region
	(g) Repetivity
	(h) Thermal Region
	(i) Spectral resolution

1. 1-g; 2-c; 3-e; 4-h; 5-d
2. 1-h; 2-f; 3-b; 4-i; 5-g
3. 1-e; 2-h; 3-g; 4-a; 5-b
4. 1-e; 2-i; 3-g; 4-h; 5-b

89. (A) One of the following is the major source of marine pollution.

1. Offshore mining and oil spills
2. Ocean dumping
3. Air borne Emission from land
4. Runoff and discharge from land

(B) Identify whether true or false and the correct sequence:

1. Vegetation of the Tundra consists largely of lichens and dwarf trees.
2. Evergreen coniferous forest is a separate biome.



3. Next to the Rain forest, the densest forests are found in seasonal tropics.
4. Savannas are tropical grasslands devoid of trees.

1. A-False; B-False; C-False; D- False
2. A-False; B-False; C-True; D-False
3. A-False; B-True; C-True; D-True
4. A-True; B-True; C-False; D-True

(C) Which two of the following ecological processes can occur because of a major disturbance such as flood, volcanic eruption or landslide in an area?

- A. Primary succession
- B. Secondary succession
- C. Change in niche structure
- D. Change in community structure

1. A and B
2. B and C
3. C and D
4. A and D

**90.** An antecedent river flowing across the footwall of a rift basin debouches into the hanging wall block incising the normal fault scarp. Later during structural inversion state to compressive regime experience lateral block movements. Finally continued compressive stresses result in thrust related uplifts and folding.

(A) Identify the tectonic landform that would develop on the normal fault scarp

1. Alluvial fans
2. Paired terraces
3. Unpaired terraces
4. Sag Ponds

(B) Choose the correct strike-slip landform

1. Sag Pond
2. Offset drainage
3. Beheaded stream
4. Unpaired terraces

(C) Choose the correct options that signify behaviour of drainage flow close to fault related fold.

- a) Drainage diversion
- b) Lake formation
- c) Stream incision
- d) River meandering

1. a, c, d
2. a, b, c
3. b, c, d
4. a, d

**91.** A spherical body produces a gravity field of 1000 gals and a rate of decrease of 0.5 mgal/m on its surface. The radius of the sphere is

(A) The radius of the sphere is

1. 6,400 km
2. 4,000 km
3. 5,000 km
4. 2,000 km

(B) The gravity field of the Earth will be half the value on its surface at a height of about

1. 1000 km
2. 1650 km
3. 2560 km
4. 1280 km

(C) In another sphere, twice the radius of the Earth but of the same density, the rate of decreases in its gravity field on the surface would be

1. 0.5 mgal/m
2. 0.25 mgal/m
3. 0.125 mgal/m
4. 1.0 mgal/m

**92.** Magnetic anomaly profiles in the vertical component and total field across a two-dimensional horizontal cylindrical body are found to be similar with each other bearing a ratio of 2:1. If the profiles exhibit even symmetry

(A) The cylindrical body strikes

1. E-W and has an effective vertical magnetization
2. E-W and has an effective horizontal magnetization
3. N-S and has an effective vertical magnetization
4. N-S and has an effective horizontal magnetization

(B) The above survey is conducted at a place of magnetic inclination

1.  $0^\circ$
2.  $30^\circ$
3.  $60^\circ$
4.  $90^\circ$

(C) Which of the following statements is true?

1. The anomalies with a larger magnitude relate to the total field; the anomalies in the horizontal component are zero everywhere
2. The anomalies with a larger magnitude relate to the vertical field; the anomalies in the horizontal component are zero everywhere
3. The anomalies with a larger magnitude relate to the total field; the anomalies in the horizontal component are similar to those in the other two components
4. The anomalies with a larger magnitude relate to the vertical component; the anomalies in the horizontal component are similar to those in the other components

**93.**  $P_{cP}$ ,  $P_{cS}$ ,  $S_{cP}$  and  $S_{cS}$  are the reflected phases of P and S waves at the fluid core-mantle boundary in an Earth model of radius 6,400 km, both the core and the mantle being homogenous and isotropic. These waves are not recorded beyond the epicentral distance of  $120^\circ$ . Then

(A)  $P_{cS}$  and  $S_{cP}$  phases

1. have common paths and are recorded simultaneously at any observatory.
2. have common paths, but are not recorded simultaneously.
3. do not have common paths, but are recorded simultaneously.
4. do not have common paths and are not recorded simultaneously.

(B) The radius of the core, in km, is

1.  $3,200\sqrt{3}$
2.  $1,600\sqrt{3}$
3. 1,600
4. 3,200

(C) If the travel time of  $P_{cP}$  phase at the epicentral distance of  $120^\circ$  is  $1000\sqrt{5}$  seconds, its velocity in (km/sec) is

1. 6.4
2. 3.2
3.  $6.4\sqrt{5}$
4.  $6.4\sqrt{5}$

**94.** The impulse (or source pulse)  $s_1=(1,0,0)$ ; velocity, thickness and density of layers are as shown in the following figure:

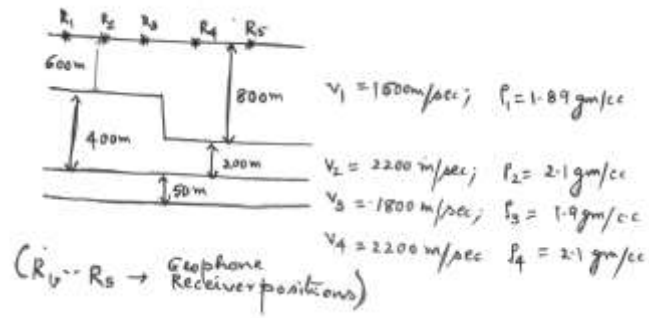

- (A) The two way travel time for layer 1, at zero offset distance at receivers  $R_1$  to  $R_5$
1. is equal
  2. differs at different receiver locations.
  3. cannot be determined correctly.
  4. would be distinctly different for the sets  $R_1$  to  $R_3$  and  $R_4$  to  $R_5$ .
- (B) The synthetic seismogram would be

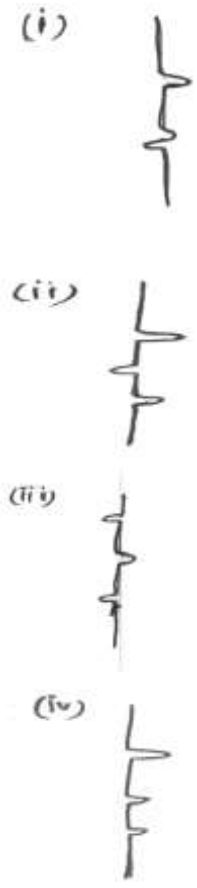

(c) Corrected the normal move out, the seismic section would be

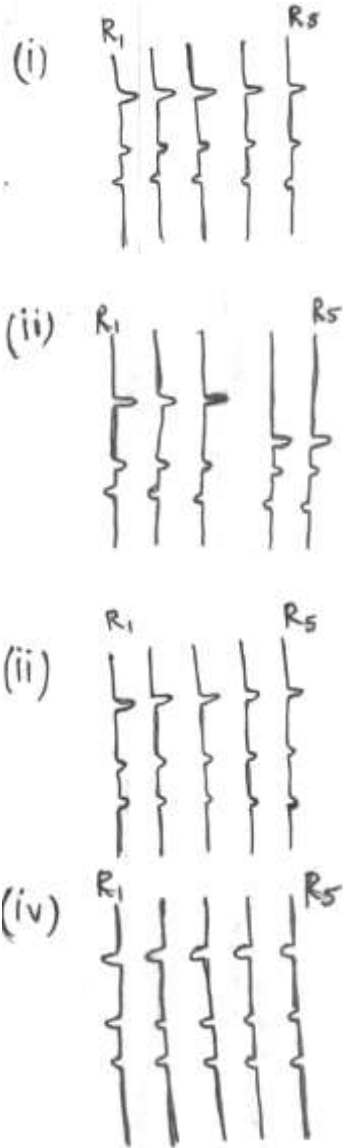

95. The geophysical data set is invariably mixed with noise components which needs to be eliminated

(A) A random stationary noise can be eliminated using

1. cross correlation
2. auto correlation
3. moving average
4. Fourier transform

(B) The Fourier transform of  $f(t) = \begin{cases} A & |t| \leq T \\ 0 & |t| > T \end{cases}$ , is

1.  $2\pi AT \frac{\sin(\omega T)}{\omega T}$
2.  $2AT \frac{\sin(\omega T)}{\omega T}$
3.  $\frac{\sin(\omega T)}{\omega T}$
4.  $\pi \frac{\sin(\omega T)}{\omega T}$

(C) If  $a_t \Rightarrow e^{-i\omega t}$  and  $f_t \Rightarrow (0.54 + 0.46Z^2)$  are the input and filter functions respectively, then the amplitude and phase of the transfer function are

1.  $\sqrt{0.5032 + \cos 2\omega}; \tan^{-1}\left(\frac{0.29 \sin 2\omega}{0.21 \sin 2\omega}\right)$
2.  $\sqrt{0.5032 + 0.50 \cos 2\omega}; \tan^{-1}\left(\frac{0.21 \sin 2\omega}{0.29 \sin 2\omega}\right)$
3.  $\sqrt{1 + \cos 2\omega}; \tan^{-1}\left(\frac{\sin 2\omega}{\cos 2\omega}\right)$
4.  $\sqrt{0.5032 + 0.50 \cos 2\omega}; \tan^{-1}\left(\frac{0.2116 \sin 2\omega}{0.54 + 0.46 \cos 2\omega}\right)$

96. (A)  $C_1C_2P_1P_2$  is array of equally spaced electrodes of separation  $a$  in which current is passed through  $C_1$  and  $C_2$  and potential is measured between  $P_1$  and  $P_2$ . The equation for apparent resistivity in terms calculated resistance  $R$  is

1.  $2\pi aR$
2.  $6\pi aR$
3.  $-6\pi aR$
4.  $3\pi aR$

(B) In magnetotelluric soundings,

1. conductivity information is obtained from shallower depth than from artificial field.
2. conductivity information is obtained from deeper depth than from artificial field.
3. no conductivity information is obtained unlike from artificial field.
4. conductivity information is equivalent to the information obtained from artificial field.

(C) A low frequency plane wave propagating along the z-axis produces a displacement current, negligible compared to the conduction current, and satisfies the differential equation  $\frac{\partial^2 B}{\partial z^2} = \mu_0 \sigma \frac{\partial B}{\partial t}$ . Then the solution is

1.  $B_{x,y}(z,t) = B_0 e^{-z/d} \cos(\omega t - z/d)$

2.  $B_{x,y}(z,t) = B_0 e^{-z/d} \cos(\omega t + z/d)$

3.  $B_{x,y}(z,t) = B_0 e^{(-z/d)\omega t}$

4.  $B_{x,y}(z,t) = 0$

where  $d$  is the skin depth,

$d = \sqrt{\frac{2}{\mu_0 \sigma \omega}}$  depends on the conductivity of the body and the frequency of the field

97. (A) The optimum solution of the following set of equations

$x + y = 1, x - y = 1, 2x + y = 1$  is

1.  $x=1, y=0$

2.  $x=5/7; y=2/7$

3.  $x=5/7; y=-1/7$

4.  $x=0; y=1$

(B) The following set of equations

$x + y = 1; 2x + 2y = 2; x - y = 1; 2x + y = 1$

1. are indeterminate, because it contains two dependent equations.

2. have an optimum single solution same as that in (A)

3. have an optimum single solution different from the one in (A)

4. have two solutions, one of which is same as that in (A)

(C) If the different equation  $dy/dx=x+y$  is satisfied at the initial values  $x=0$  and  $y=1$ , then the value of  $y$  at  $x=0.2$ , with Runge-Kutta method is

1. 1.2428

2. 1.4268

3. 1.4678

4. 1.5027

98. The magnetic anomaly profile perpendicular to a tectonic feature is shown below:

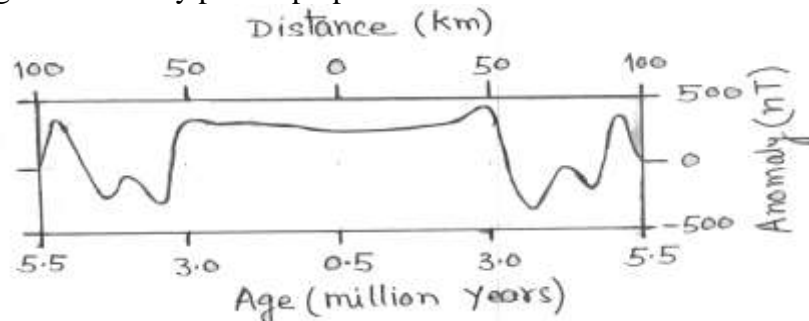

- (A) If a rock sample collected from the feature shows its permanent magnetism dipping up at  $-30^\circ$ , the feature is located at the time of its magnetization at about
1.  $16^\circ\text{S}$
  2.  $16^\circ\text{N}$
  3.  $30^\circ\text{S}$
  4.  $30^\circ\text{N}$
- (B) The tectonic feature exhibits
1. strong negative Bouguer and subdued free-air anomalies.
  2. strong positive Bouguer and subdued free-air anomalies.
  3. strong free-air and subdued Bouguer anomalies.
  4. subdued free-air and Bouguer anomalies.
- (C) The tectonic feature represents
1. an active mid-oceanic ridge with spreading half rate of 4 cm/yr
  2. an inactive mid-oceanic ridge with spreading half rate of 4 cm/yr
  3. a subducting plate zone with subduction rate of 4 cm/yr
  4. a subducting plate zone with subduction rate of 2 cm/yr

**99.** If the earth is

(A) Uniform, homogeneous and isotropic, then the potential  $U$  satisfies

1.  $\nabla^2 U = \text{constant}$
2.  $\nabla^2 U = \nabla U$
3.  $\nabla^2 U = 0$
4.  $\nabla U = \text{constant}$

(B) If a part of the media is conductive then

1.  $\nabla \times E = \frac{-\partial B}{\partial t}$
2.  $\nabla \times H = \frac{-\partial E}{\partial t}$
3.  $\nabla \times E = \frac{-\partial H}{\partial t}$
4.  $\nabla^2 E = 0$

[E- electric field intensity; H-magnetic field intensity; B-magnetic flux; t-time]

(C) Which of the following hold good both for elastic and conductive media



1.  $\nabla^v U = 0$
2.  $\nabla^v U = \text{constant}$
3.  $\nabla^v U = \frac{1}{C^v} \frac{\partial^v U}{\partial t^v}$
4.  $\nabla^v U = \frac{1}{C^v} \frac{\partial U}{\partial t}$

where C is the velocity of the wave

100. (A) If the Bulk-water-wet resistivity of a rock sample  $P_o = 40\Omega m$  and the resistivity of the water contained in its pores  $P_w = 30\Omega m$  then formation P resistivity factor is

1.  $40/30=1.333$
2.  $30/40=0.75$
3.  $40 \times 30=1200$
4.  $40+30=70$

(B) Formation resistivity factor F is determined as

1.  $F = P_o P_w$
  2.  $F = P_w/P_o$
  3.  $F = C P_o P_w$
  4.  $F = P_o/P_w$
- {  $P_o$  - bulk-water-wet resistivity }  
 {  $P_w$  - resistivity of water contained in pores }

(C)

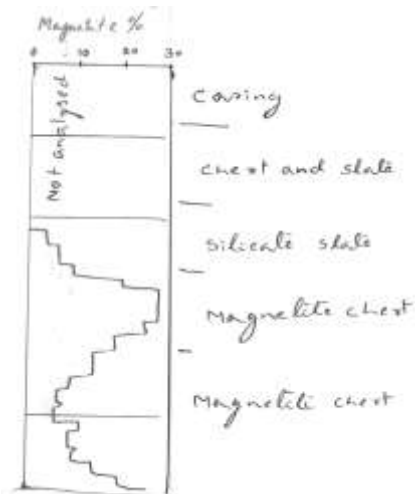

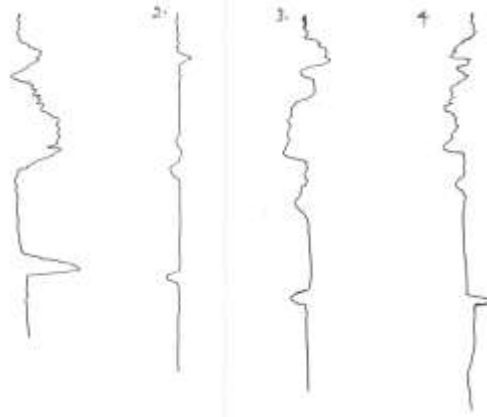

The Chert and slate beds are identified from well log data using relative-ray intensity, Resistivity and magnetic susceptibility logs. The stratified beds are given here and identify the correct log sections.

1. 1
2. 2
3. 3
4. 4

**101.** (A) Match the following instruments used in satellite meteorology with the parameter which they measure:

A	Scatterometer	(i)	Under water earthquakes
B	Ocean Colour Monitor	(ii)	Cyclone tracks
C	Altimeter	(iii)	Chlorophyll-a
D	Microwave radiometer	(iv)	Winds
E	Infrared radiometer	(v)	Ocean currents
		(vi)	Sea level
		(vii)	Sea Surface Temperature
		(viii)	Rainfall

- (1) A-(i), B-(ii), C-(iii), D-(iv) and E-(v)
- (2) A-(iv), B-(iii), C-(vi), D-(viii), and E- (vii)
- (3) A-(viii), B-(vii), C-(vi), D-(v), and E-(iv)
- (4) A-(vii), B-(v), C-(iii), D-(i), and E-(ii)

(B) The radiances measured from the tops of four different clouds are respectively (A)  $100 \text{ W m}^{-2}$  (B)  $150 \text{ W m}^{-2}$ , (C)  $125 \text{ W m}^{-2}$  and (D)  $90 \text{ W m}^{-2}$ . Which is the increasing order of altitudes of these clouds?

1. B, C, D, A
2. A, B, C, D
3. B, A, D, C
4. B, C, A, D

(C) A satellite going around a planet of radius 6000 km, at a height of 36,000 km from its surface takes a day to complete one revolution. What would be the period of another satellite orbiting the same planet at half the altitude (i.e., 18,000 km from the surface)?

1. higher by a factor of  $\left(\frac{4}{7}\right)^{3/2}$
2. lower by a factor of  $\left(\frac{4}{7}\right)^{3/2}$
3. Higher by a factor of  $\left(\frac{3}{7}\right)^{3/2}$
4. Lower by a factor of  $\left(\frac{3}{7}\right)^{3/2}$

**102.(A)** Identify the correct statement:

1. Atmospheric CO<sub>2</sub> concentration in forests is lower during the night than During the day
2. The energy derived by burning fossil fuels (coal, oil, wood etc.) comes from The Sun
3. The burning of agricultural products (hay etc.) increases the atmospheric Carbon dioxide concentration.
4. Stronger oxidants than oxygen can persist for long in natural environments.

(B) The journal *Science* noted a particular molecule as the ‘molecule of the year’ This molecule destroys ozone, is a precursor of acid rain and is essential to activities in the human brain and body’s immune system. Identify this molecule:

1. Carbon dioxide
2. Methane
3. Nitric Oxide
4. Sulphur dioxide

(C) The energy required to dissociate NO<sub>2</sub> to NO+O in the Earth’s atmosphere by photolysis is 304 kJ/mole. What should be the minimum frequency of electromagnetic radiation required for dissociating NO<sub>2</sub> ?

1.  $7.62 \times 10^{14}$  Hz
2.  $7.62 \times 10^{15}$  Hz
3.  $7.62 \times 10^{13}$  Hz
4.  $7.62 \times$  GHz

**103(A)** The speeds of incompressible fluid elements across the different faces of A small cubic volume of side ‘a’ are shown below. Find the value of x

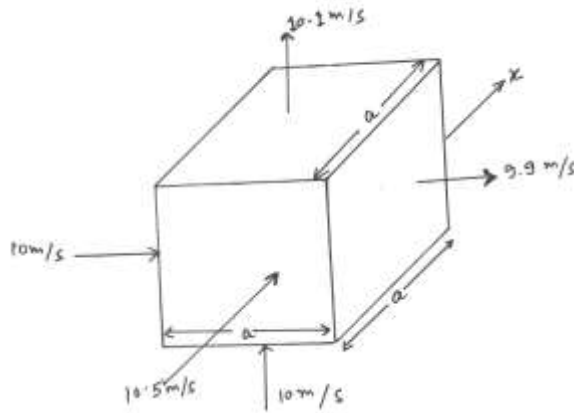

1. 10 m/s
  2. 10.5 m/s
  3. 10.1 m/s
  4. 9.9 m/s
- (B) the velocity field of a fluid is given by  $x\hat{i} + z\hat{j} + y\hat{k}$  in the Cartesian coordinates. Which of the following is true for this field?
1. The fluid is incompressible
  2. The flow is irrotational
  3. The vorticity is positive definite
  4. The acceleration is zero
- (C) For the velocity field given in (b) what is the Coriolis force? ( $\Omega$  = angular velocity of the earth)
1.  $-2\Omega [z\hat{i} + x\hat{j}]$
  2.  $-2\Omega [x\hat{i} + z\hat{j}]$
  3.  $[x\hat{i} + z\hat{j} + y\hat{k}]2\Omega \sin \theta$
  4.  $[x\hat{i} + z\hat{j} + y\hat{k}]2\Omega \cos \theta$
- 104.(A)** The hydrostatic approximation used in general circulation models assures that
- (i) the atmosphere is static and devoid of motions
  - (ii) the motion in the vertical is small compared to the horizontal motion
  - (iii)  $p = hgP$ , where  $p$  = pressure,  $h$  = altitude and  $g$  = acceleration due to gravity and  $P$  = density of air
  - (iv) Motion in the horizontal is negligible compared to motion in the vertical.
- The correct statements from the list above are

1. (i) and (ii)
2. (ii) and (iii)
3. (iii) and (iv)
4. only (iii)

(B) Ocean-atmosphere coupled models are more useful in the following time scales

1. hourly
2. daily
3. weekly
4. seasonal

(C) Identify whether the following statements are true or false, and identify the correct sequence.

- (i) Zonal mixing is more efficient than meridional mixing
- (ii) A zonal wind of 1m/s at 60°N has a higher angular momentum per unit mass than a zonal wind of 1m/s at 30°N
- (iii) ice-albedo feedback is a positive feed back
- (iv) Water vapour is not a greenhouse gas
- (v) El-Nino happens in the Eastern Pacific

1. (i) True; (ii) False; (iii) True; (iv) False; (v) True
2. (i) False; (ii) False; (iii) True; (iv) False; (v) True
3. (i) False; (ii) True; (iii) False; (iv) False; (v) True
4. (i) True; (ii) True; (iii) True; (iv) True; (v) False

**105.(A)** Which of the following statements are correct regarding sunspots?

- (i) they are cooler regions on the solid surface relative to their surroundings
- (ii) They are hotter regions on the solar surface relative to their surroundings
- (iii) They are regions where magnetic fields are higher
- (iv) They are regions where there are no magnetic fields

1. (i) and (iii)
2. (ii) and (iv)
3. (i) and (ii)
4. (iii) and (iv)

(B) The solar maximum occurs

1. once in 11 years, when the sun spot number is close to zero
2. once in 22 years, when sunspot number is maximum
3. once in 11 years, when sunspot number is maximum
4. once in 22 years, when the sun spot number is close to zero

(C) Cosmic rays are modulated by solar activity and therefore production of radioisotopes such as  $^{14}\text{C}$  in the Earth's atmosphere caused by cosmic rays are affected by solar activity

1. One can expect a 50 year periodicity in the  $^{14}\text{C}$  production
2. One can expect all known climatic periodicities in  $^{14}\text{C}$  production
3. One cannot expect any solar periodicities in  $^{14}\text{C}$  production because its half life is 5700 years.
4. The longest solar periods are likely to be reflected in  $^{14}\text{C}$  records.

**106.(A)** Identify the positive feedbacks from the list below;

- (i) Vegetation - rain
- (ii) aerosols - clouds
- (iii) aerosols - isolation at surface
- (iv) methane - radiative forcing
- (v) nitrous oxide - tropospheric ozone

1. (i), (ii) and (iv)
2. (i) and (ii)
3. (iii) and (iv)
4. (i) and (iii)

(B) Identify the false statements from the list below:

- (i) Coriolis force for horizontal winds is maximum near the equator
- (ii) Rain releases latent heat in the troposphere
- (iii) Stratosphere has the maximum water content
- (iv) Geostrophic flow is parallel to isobars
- (v) Maximum pressure gradient is along isobars

1. (i), (iii) and (v)
2. (ii) and (iv)
3. (i), (ii) and (iii)
4. (i), (iii) and (iv)

(C) Solar radiation of  $2 \times 10^7 \text{ J}$  is received by a dry air parcel of 1 atm. pressure leading to an increase in its volume by  $44 \text{ m}^3$ , with no change in the position of its centre of mass. What is the approximate change in the internal energy of the parcel?

1. 44 J
2.  $1.56 \times 10^6 \text{ J}$
3.  $156 \times 10^6 \text{ J}$
4.  $15.6 \times 10^6 \text{ J}$

107.(A)

The Clausius-Clapeyron equation gives the amount of water vapour that can saturate the atmosphere at a given temperature. Which of the following diagrams correctly depicts the variation of  $p_e$  (partial pressure of water vapour) with absolute temperature  $T$ ?

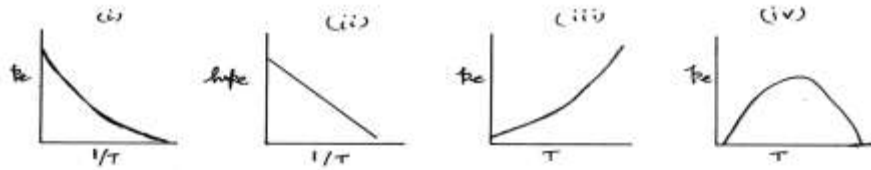

1. (i) and only
2. (i) and (ii)
3. (i), (ii) and (iii)
4. (iv)

(B) Identify the correct diagrams that describe the variation of pressure ( $p$ ) with altitude ( $h$ ) in the earth's atmosphere:

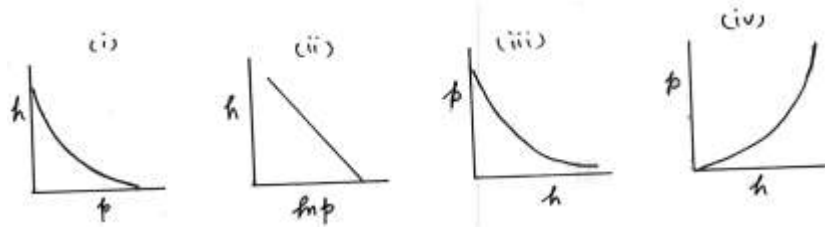

1. (i) only
2. (i) and (ii)
3. (i), (ii) and (iii)
4. (ii) and (iii)

(C) Identify the isentropic process/processes in the following list;

- (i) Expansion of a filled, closed rubber balloon as it goes up
- (ii) Rapid ascent of an air parcel
- (iii) Condensation of water vapour to rain
- (iv) Evaporation from the ocean surface

1. (i) only
2. (ii) and (i)
3. (iii) and (iv)
4. (iv) only

108.(A)

Considering  $R_e$  to be the radius of the Earth and  $T$  its mean absolute temperature,  $\alpha$  as its mean albedo,  $S_0$  the solar constant and  $\sigma$  Stefan's constant, the simple energy balance model can be written as;

1.  $S_0(1-\alpha) = \sigma T^4$
2.  $\frac{S_0}{4}(1-\alpha) = 4\pi R_e^2 \sigma T^4$
3.  $S_0(1-\alpha) = 4\pi R_e^2 \sigma T^4$
4.  $\frac{S_0}{4}(1-\alpha) = \pi R_e^2 \sigma T^4$

(B) The percent change in temperature for one percent increase in solar constant is

1. 4
2. 0.25
3. 1
4. 2

(C) The percent changes in the temperature for a 8% reduction in albedo (when the mean albedo is 0.33) is

1. +0.01
2. -0.01
3. 0.1
4. -0.1

**109.(A)** Which among the inner planet of the solar system does exhibit “run away” greenhouse effect

1. Mercury
2. Venus
3. Earth
4. Mars

(B) Martian atmosphere contains more carbon dioxide than the Earth’s atmosphere. Yet Martian atmosphere is cooler than that of the Earth. This is because the Martian atmosphere

1. contains trace amounts of sulphate aerosols
2. is underlain by a higher albedo surface
3. includes emission from the largest volcano in the solar system
4. is farther away from the sun

(C) Mercury has a lower mean surface temperature than Venus because

1. Mercury is closer to the sun than Venus
2. Venus is closer to the sun than Mercury
3. Mercury has no atmosphere
4. Venus has no atmosphere



110. (A) When unsaturated air parcel undergoes vertical ascent it

1. becomes saturated due to cooling
2. becomes saturated due to expansion
3. remains unsaturated due to expansion
4. remains unsaturated due to cooling

(B) Bowen ratio is defined as

1. advective flux/diffusive flux
2. diffusive flux/advective flux
3. sensible heat flux/latent heat flux
4. latent heat flux/sensible heat flux

(C) In fluid flow, turbulent stress is proportional to

1. wind speed
2. square of the wind speed
3. square root of the wind speed
4. cube of the wind speed

111. (A). Which of the following configurations of the Sun (S), the Earth (E) and the moon (M) is likely to give rise to neap tide?

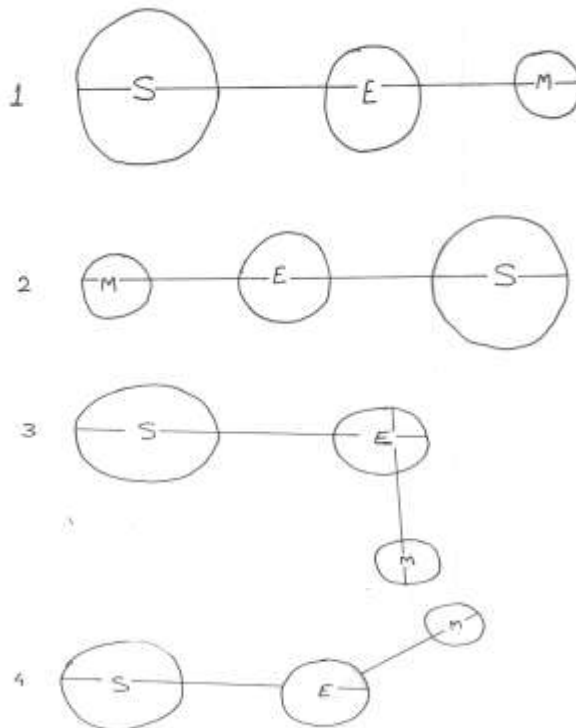

- (B) The following diagram shows a part of the tide gauge record at the port of Mumbai. Identify the type of tide.

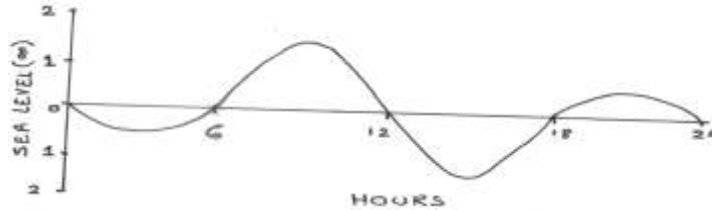

1. diurnal
  2. semi-diurnal
  3. mixed diurnal
  4. mixed semi-diurnal
- (C) Tides occur from the balance between
1. Gravitational force and Coriolis force
  2. Coriolis force and centrifugal force
  3. Centrifugal force and gravitational force
  4. Gravitational force and pressure gradient force
- 112.** (A) Surface gravity wave, when propagates from the deep ocean to shallow water, undergoes refraction. Identify true and false statements and the correct sequence:
- (i) wave height decreases
  - (ii) wave period increases
  - (iii) wave speed increases
  - (iv) wave length decreases
1. (i) – false;(ii)-false; (iii)-true;(iv)-true
  2. (i) – true ;(ii)-false; (iii)-false;(iv)-true
  3. (i) – false;(ii)-true; (iii)-true; (iv)-false
  4. (i) – false;(ii)-true ;(iii)-false ;(iv)- true
- (B) Pick the correct statement that differentiates rip –current and alongshore current.
1. alongshore currents occur along a gently sloping beach and rip currents along a steeply sloping beach.
  2. alongshore currents occur due to wave refraction and rip current due to wave diffraction.
  3. alongshore currents is a shore parallel current while rip current is perpendicular to the shore.
  4. alongshore currents is wind driven while the rip current is density driven.
- (C) Identify the INCORRECT statement:
1. Maximum wave height is defined as the height of the highest wave observed in a 10 minutes interval during a storm.
  2. Significant wave height is the mean height of the third of the waves.
  3. Extreme wave height is the height of the highest wave during the entire period of the storm.
  4. Wave height does not depend upon the fetch of the wind and the time it has been blowing.

113. (A) The vertical profiles of the temperature and the salinity are given in the diagram. Identify the regions marked as I,II, III and IV. (BL= Barrier Layer; MLD= Mixed Layer Depth, ITL= Isothermal Layer)

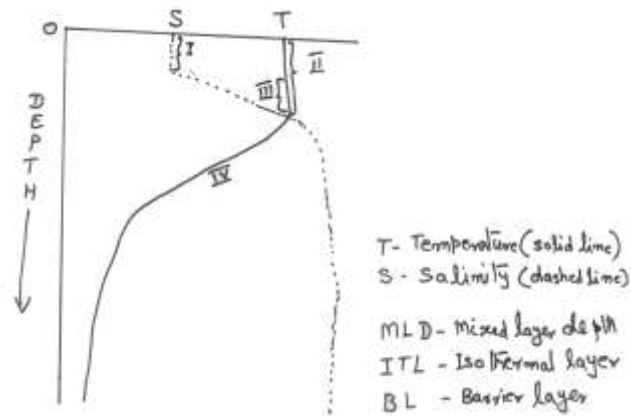

1. ITL, BL, MLD, Thermocline
  2. MLD,ITL, BL, Thermocline
  3. BL, MLD, Thermocline,ITL
  4. MLD, BL. ITL, Thermocline
- (B) What causes the formation of the Barrier Layer
1. Evaporation exceeds precipitation
  2. Precipitation exceeds evaporation
  3. Warming exceeds cooling
  4. Cooling exceeds warming
- (C) Which of the following statements regarding mixed layer formation is INCORRECT?
1. Increased wind leads to increased mixed layer depth.
  2. Increased cooling of surface water decreases mixed layer depth.
  3. Increased evaporation increases mixed layer depth.
  4. Increased precipitation decreases the mixed layer depth.

114.

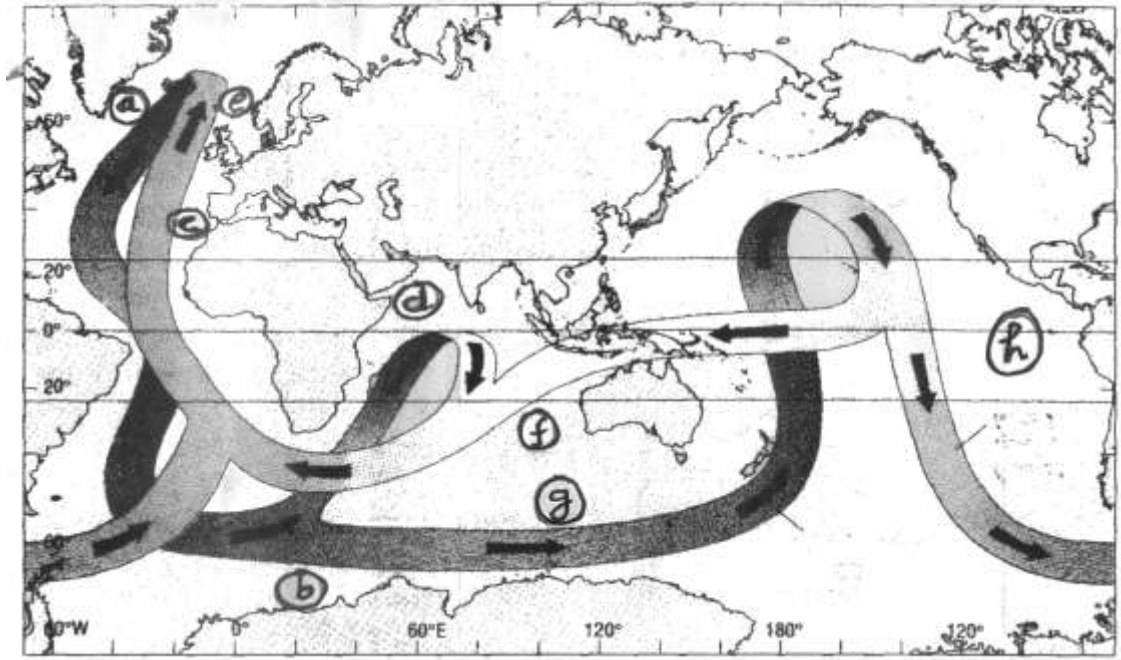

The above diagram shows the great oceanic conveyor belt. Some of the regions of significance have been marked as (a),(b),(c),(d),(e),(f),(g) and (h). Answer the following:

(A) The areas where large quantities of deep bottom water forms are

1. (a) and (e)
2. (a) and (g)
3. (c) and (d)
4. (a) and (b)

(B) The areas of continental warming due to heat transport by the conveyor belt are

1. (b) and (g)
2. (h) and (b)
3. (a) and (e)
4. (d) and (b)

(C) Highly saline waters sink into deep ocean in the areas

1. (a),(b),(c) and (d)
2. (e) and (h)
3. (f) and (g)
4. (f) and (h)

115. The stable carbon and oxygen isotope analyses of planktic foraminifera from the Arabian Sea sediment core are presented in the table below

Depth in core (m)	Age(ka)	$\delta^{13}\text{C}$	$\delta^{18}\text{O}$ (
0	0	-1.0	-2.1
10	5	-1.1	-2.3
20	10	-1.2	-2.0
30	15	-1.8	-1.8
40	20	-2.0	-0.8

Higher values of  $\delta^{13}\text{C}$  indicate increased organic productivity and higher  $\delta^{18}\text{O}$  values represent lower sea level/lower monsoon discharge.

(A) The mean sedimentation rate is

1. 2 cm/ka
2. 1 cm/ka
3. 10 cm/ka
4. 20 cm/ka

(B) The monsoon run off was considerably small

1. during the Holocene
2. during the 20 ka
3. during the period represented by 20 cm depth
4. during the most recent past

(C) Higher organic productivity is observed at

1. 40 cm depth
2. 15 ka
3. only at 20 cm depth
4. throughout the Holocene

**116.** (A) For increasing the ocean productivity in high nutrient –low chlorophyll regions iron is often added. It is added in the form of

1. iron fillings
2. ferrous sulphate directly to sea water
3. ferrous sulphate to sea water, after reducing its pH to 2
4. ferric chloride

(B) The relative proportion of dissolved  $\text{CO}_2$ , bicarbonate and carbonate at a ocean pH of 8.2 is respectively,

1. 25%, 50%, 25%
2. 10%, 80%, 10%
3. 80%, 10%, 10%
4. 10%, 10%, 80%

(C) pCO<sub>2</sub> in ocean waters is measured along a north-south track in the Indian ocean. Other parameters such as SST, salinity, oxygen content are also measured. Identify the observations which are correct:

1. SST decreases southwards
2. pCO<sub>2</sub> decreases southwards
3. pCO<sub>2</sub> increases northwards
4. SST increases southwards

117.

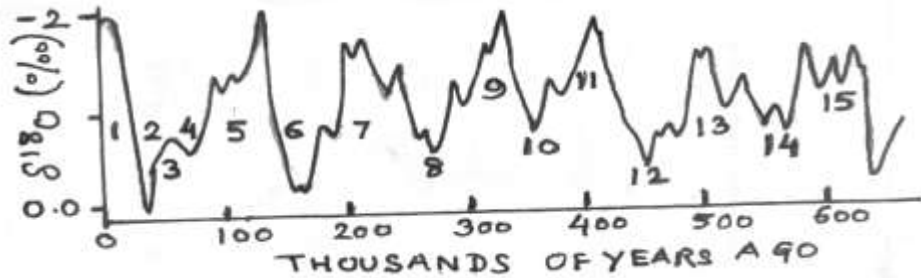

The above figure shows cyclic variations in oxygen isotope composition ( $\delta^{18}\text{O}$ ) of the planktic foraminifera from a dated deep ocean core which indicate successive glacial-interglacial stages (numbered 1 to 15)

(A) Which of the following statements is correct?

1. The cyclicity is due to periodic change in sea surface temperature (SST) only.
2. The cyclicity is due to periodic changes in the oxygen isotopic composition of ocean water only
3. The cyclicity is due to a combined effect of changes in SST and the oxygen isotope composition of ocean water.
4. The cyclicity is due to changing vital effect of planktic foraminifera with time.

(B) Which of the following statements is INCORRECT?

1. All odd numbered stages are glacial.
2. All odd numbered stages are interglacial
3. All even numbered stages are glacial.
4. Increase in  $\delta^{18}\text{O}$  values mark glacial stages.

(C) Which of the following statements is CORRECT?

1. The 100,000 years old sediments could be dated by <sup>230</sup>Th dating method.
2. The 200,000 years old sediments could be dated by <sup>14</sup>C dating method.
3. The climate cycles are only due to the changes in Earth's eccentricity.
4. The climate cycles are only due to the changes in earth's obliquity.

118.(A) Along the west coast of India, during upwelling the phytoplankton biomass increases because

1. Sunlight is able to penetrate deeper
2. Lower temperature supports increased biological production

3. Nutrient supply increases
4. Water column becomes more stable

(B) The biological pump refers to

1. The production of organic matter and the outgassing of oxygen.
2. The production of organic matter and its transport to the ocean bottom.
3. Degradation of organic matter and outgassing of CO<sub>2</sub>.
4. organic debris falling on the ocean floor.

(C) Match the following and identify the correct sequence

- |      |                      |       |                                |
|------|----------------------|-------|--------------------------------|
| i)   | New production       | viii) | Atmospheric nitrogen fixation  |
| ii)  | Oxygen minimum zone  | ix)   | Increased solar radiation      |
| iii) | HNLC                 | x)    | Arabian sea                    |
| iv)  | <i>Trichodesmium</i> | xi)   | Upwelling                      |
| v)   | Stratification       | xii)  | Southern Ocean                 |
| vi)  | Ocean acidification  | xiii) | Atmospheric nitrate deposition |
| vii) | La Nina              | xiv)  | Sea ice                        |
|      |                      | xv)   | Increased CO <sub>2</sub>      |

1. (i)-(viii); (ii)-(ix); (iii)-(x); (iv)-(xi); (v)-(xii); (vi)-xiii); (vii)-(xv)
2. (i)-(viii); (ii)-(ix); (iii)-(x); (iv)-(xi); (v)-(xii); (vi)-xiii); (vii)-(xiv)
3. (i)-(xv); (ii)-(xii); (iii)-(xi); (iv)-(x); (v)-(xiv); (vi)-(xiii); (vii)-(ix)
4. (i)-(xiii); (ii)-(x); (iii)-(xii); (iv)-(viii); (v)-(ix); (vi)-(xv); (vii)-(xi)

119.(A) Identify the correct statement:

1. North equatorial currents move eastward
2. Equatorial undercurrent is present only in winter
3. South equatorial current is not seasonal
4. Equatorial counter current is absent in the Indian Ocean.

(B) Upwelling off the coast of Somalia leads to a decrease in

1. The pCO<sub>2</sub> of surface waters
2. The nutrient concentration of surface waters
3. Piracy
4. Sea surface temperature

(C) Match the following and identify the correct statement:

- |      |                 |       |                      |      |              |
|------|-----------------|-------|----------------------|------|--------------|
| i)   | Somali current  | v)    | Equatorially trapped | ix)  | Coupled mode |
| ii)  | El Nino         | vi)   | Meso scale process   | x)   | Shoaling     |
| iii) | Kelvin wave     | vii)  | Pacific Ocean        | xi)  | of Isotherm  |
| iv)  | Cold –core eddy | viii) | Western Boundary     | xii) | Seasonal     |
|      |                 |       |                      |      | Eastward     |
|      |                 |       |                      |      | propagation  |

1. (i)-(viii)-(xi); (ii)-(vii)-(ix); (iii)-(v)-(xii); (iv)-(vi)-(x)
2. (i)-(viii)-(xii); (ii)-(vii)-(xi); (iii)-(v)-(ix); (iv)-(vi)-(x)

3. (i)-(vi)-(x); (ii)-(v)-(xii); (iii)-(vii)-(xi); (iv)-(viii)-(ix)
4. (i)-(v)-(ix); (ii)-(vi)-(ix); (iii)-(vii)-(xi); (iv)-(viii)-(xii)

120.(A) Chemosynthetic bacteria occur in the following environment:

1. Deep ocean floor
2. Mid ocean floor
3. Hydrothermal vent
4. Oxygen minimum zone

(B) Which of the following is NOT caused by the climate change?

1. bleaching of corals
2. melting of glaciers
3. denitrification
4. slowing down of the global conveyor circulation

(C) which of the following are associated with coastal pollution?

- |       |                      |     |                            |
|-------|----------------------|-----|----------------------------|
| i).   | eutrophication       | ii) | fish mortality             |
| iii). | oxygen depletion and | iv) | alteration of the food web |

1. (i) only
2. (i) and (ii)
3. (i), (ii) and (iv)
4. (i), (ii) and (iii)